



U.S. DEPARTMENT OF  
**ENERGY**

# Advanced Transmission Technologies

December 2020

United States Department of Energy  
Washington, DC 20585

# Executive Summary

The high-voltage transmission electric grid is a complex, interconnected, and interdependent system that is responsible for providing safe, reliable, and cost-effective electricity to customers. In the United States, the transmission system is comprised of three distinct power grids, or “interconnections”: the Eastern Interconnection, the Western Interconnection, and a smaller grid containing most of Texas. The three systems have weak ties between them to act as power transfers, but they largely rely on independent systems to remain stable and reliable. Along with aged assets, primarily from the 1960s and 1970s, the electric power system is evolving, from consisting of predominantly reliable, dependable, and variable-output generation sources (e.g., coal, natural gas, and hydroelectric) to increasing percentages of climate- and weather- dependent intermittent power generation sources (e.g., wind and solar). All of these generation sources rely heavily on high-voltage transmission lines, substations, and the distribution grid to bring electric power to the customers.

The original vertically-integrated system design was simple, following the path of generation to transmission to distribution to customer. The centralized control paradigm in which generation is dispatched to serve variable customer demands is being challenged with greater deployment of distributed energy resources (at both the transmission and distribution level), which may not follow the traditional path mentioned above. This means an electricity customer today could be a generation source tomorrow if wind or solar assets were on their privately-owned property. The fact that customers can now be power sources means that they do not have to wholly rely on their utility to serve their needs and they could sell power back to the utility. However, the utility still has to maintain the electric infrastructure to the customer if the utility and associated the privately-owned generation cannot produce enough power to meet required load. This results in added utility expenditures without any further customer revenue, though with the benefit that the arrangement contributes to grid resilience and customer safety when the utility manages an outage caused by extreme weather or another issue.

The increasing adoption of electric vehicles is also introducing electric demand growth. Since electric vehicle (EV) charging demands are mobile, there is increased variability as to where on the electric system the demand may appear in real time. Meeting this EV need is a unique challenge to system designers and operators of the electric grid to manage real-time operations, system growth, and infrastructure improvements. These broad system changes have created a need for advanced solutions to help solve modern operational challenges and to address the limitations and risks associated with aged infrastructure.

The transmission system in operation today is the backbone of the electricity delivery system that connects all grid resources and acts as the path for electricity to flow from generation to demand. Advanced transmission technologies, coupled with advanced computational and advanced dynamic situational awareness, are a suite of tools that can help address transmission challenges, improving the efficiency and effectiveness of electricity delivery and increasing the reliability and resilience of the system.

Other technologies, such as energy storage, microgrids, and distributed controls, can also help support the overall objectives of the electric power system. Underpinning the various grid challenges is the fundamental need to perform real-time balancing of generator outputs to meet demand—at all times and across all regions—within the limits and capabilities of the underlying hardware. Enhanced planning and optimization methods can help minimize operating costs, while new hardware capabilities can help move more power by upgrading existing line materials using existing transmission pathways. These new capabilities become more critical with a growing number of evolving threats from cyber-attacks and extreme weather events, among others.

Notably, enhanced security against cyber-attacks has become a priority for DOE in recent years. In 2020, DOE released a Request for Information (RFI) to better understand the current state and gaps in supply chain risk management, as intelligent electronics made abroad may be compromised by adversaries. As cyber and foreign threats increase and evolve, it is especially important that DOE is aware of and properly prioritizes defending against these risks to maintain a reliable grid for all customers.

Several advanced transmission technologies can be used to improve and enhance the transmission system, spanning both grid software and grid hardware. Sensor and software solutions (e.g., dynamic line rating, topology optimization) focus on improvements in the control center, control and protection systems, advanced optical sensing and metering tools, real-time contingency analysis tools, and artificial intelligence-assisted operator decision-making processes. These technologies generally improve upon a short-term system outlook, such as day-ahead or real-time applications, rather than a longer-term planning horizon. Actuator and hardware solutions (e.g., power flow controllers, advanced conductors, and cables) focus on improvements in the physical assets and infrastructure responsible for carrying, converting, or controlling electricity. These technologies are generally more capital-intensive than sensor and software solutions and improve the long-term reliability and resilience of the grid. This suite of technologies can be used in isolation or in tandem to improve the overall efficiency and effectiveness of the transmission network. Additionally, these technologies can help increase the reliability and resilience of the entire electric power system. Finally, they can also assist the designers to envision and create the system of the future that can rapidly adapt and change as the demand and use cases for electricity evolve.

Advanced transmission technologies are diverse in maturity, application, and capabilities. These technologies all possess different capabilities that present opportunities to improve the transmission system, but they also face unique barriers. Selecting the optimal set of technologies for a given situation will require assessments that can evaluate advanced transmission technologies against one another, as well as against traditional solutions. Although direct economic benefits can be apparent, other benefits are harder to quantify, such as improved situational awareness, asset deferral, and improved resilience. A robust framework and methodology, along with associated modeling and simulation tools, are needed to support this determination.

Despite the potential benefits offered by these advanced transmission technologies, several broad issues impede their integration and adoption. Ensuring safety of utility personnel when working on equipment, market readiness, market design issues, insufficient incentives, misalignment of incentives, utility risk aversion due to traditional liability issues, operator training to achieve proficiency, planning limitations, incumbency issues, third party operation of equipment, and mitigation of cybersecurity concerns are all challenges that require nontechnical solutions and new approaches by utilities, grid operators, and regulators. In most cases, cost reductions and proven field performance are requirements for broader deployment. The U.S. Department of Energy, working in concert with the private sector and research institutions, can support education, research, development, and demonstration efforts to address these barriers and concerns. Success in these endeavors can accelerate commercialization of products that will see growing markets worldwide. Investing in advanced transmission technologies presents opportunities for U.S. leadership and domestic manufacturing, especially with grid hardware and computational technologies.

## Abbreviations

AAAC	All Aluminum Alloy Conductor
AAR	ambient adjusted ratings
AC	alternating current
ACAR	Aluminum Conductor Alloy Reinforced
ACCC	Aluminum Conductor Composite Core
ACCR	Aluminum Conductor Composite Reinforced
ACFR	Aluminum Conductor Carbon Fiber Reinforced
ACSR	Aluminum Conductor Steel Reinforced
ACSS	Aluminum Conductor Steel Supported
AOHC	advanced overhead conductors
ASEA	Allmänna Svenska Elektriska Aktiebolaget
BSCCO	bismuth strontium calcium copper oxygen
CAISO	California Independent System Operator
CFE	Comisión Federal de Electricidad
CIGRE	International Council on Large Electric Systems
CMP	Constraint Management Plans
DER	distributed energy resources
DLR	dynamic line rating
DOE	Department of Energy
DSR	distributed series reactor
EMS	Energy Management System
ERCOT	Electricity Reliability Council of Texas
FACTS	flexible AC transmission systems
FERC	Federal Energy Regulatory Commission
FTR	Financial Transmission Rights
GENI	Green Electricity Network Integration
GW	gigawatt
HVAC	High-Voltage Alternating Current
HTLS	high-temperature, low-sag
HTS	high-temperature superconductor
HVDC	High-Voltage Direct Current
IEC	International Electrotechnical Commission
IEEE	Institute for Electrical and Electronics Engineers
ISO	Independent System Operator
LADWP	Los Angeles Department of Water and Power
MI	mass impregnated
MISO	Midcontinent Independent System Operator
MTDC	Multi-terminal HVDC
MVDC	Medium Voltage Direct Current
MW	megawatt

NERC	North American Electric Reliability Corporation
NYISO	New York Independent System Operator
NYPA	New York Power Authority
O&M	operations and maintenance
PAC	phase angle controllers
PAR	phase angle regulators
PFC	power flow controllers
PJM	PJM Interconnection LLC
PST	phase-shifting transformers
RAS	Remedial Action Schemes
ReBCO	Rare Earth–Barium–Copper Oxide
REG	Resilient Electric Grid
ROW	rights-of-way
RTO	regional transmission organization
SCADA	supervisory control and data acquisition
SLR	seasonal line ratings
SPP	Southwest Power Pool
SPS	Special Protection Schemes
SSPS	Solid State Power Substation
SSSC	Static Series Synchronous Compensator
STATCOM	Static Synchronous Compensator
SVC	Static Var Compensators
TACSR	Thermal-Resistant Aluminum Alloy Conductor Steel Reinforced
TCSC	Thyristor-Controlled Series Capacitor
UHVDC	ultra-high-voltage direct current
UPFC	Unified Power Flow Controller
WAPA	Western Area Power Administration
XLPE	cross-linked polyethylene



# Advanced Transmission Technologies

## Table of Contents

II.	Introduction .....	1
	Electric Grid Challenges .....	2
	Advanced Transmission Technologies.....	5
III.	Sensors and Software Solutions .....	6
	Dynamic Line Rating .....	6
	Opportunities.....	7
	Specific Barriers .....	9
	Topology Optimization .....	11
	Opportunities.....	122
	Specific Barriers .....	144
IV.	Actuators and Hardware Solutions.....	16
	Power Flow Controllers: Alternating Current Technologies.....	16
	Opportunities.....	17
	Specific Barriers .....	19
	Power Flow Controllers: Direct Current Technologies.....	21
	Opportunities.....	233
	Specific Barriers .....	244
	Advanced Conductors and Cables.....	25
	Opportunities.....	26
	Specific Barriers .....	27
V.	Integration and Adoption Challenges .....	28
VI.	Conclusion.....	322
VII.	Appendix .....	344
VIII.	Bibliography .....	48

## II. Introduction

The high-voltage transmission electric grid is a complex interconnected and interdependent system that is responsible for providing safe, reliable, and cost-effective electricity to customers. Developed and built over the last 125 years, the U.S. electric power system has been called the “world’s largest machine and part of the greatest engineering achievement of the 20th century” [1]. The electric transmission and distribution infrastructure and the energy delivery it facilitates represent an essential fabric of the modern economy, for both comfort and safety of customers. Whether the grid is powering manufacturing, essential health services, sanitation needs, or providing energy to the systems that support modern communication machinery, the presence of such is noticeable instantly during a sudden failure.

Recently, investments in the grid have focused on improving reliability, efficiency, and resilience to meet the growing dependence on electricity across all sectors. This is a complicated task in which generation and use must be balanced continuously, the ability to store electricity cost-effectively is limited, and energy consumption patterns are ever-changing.

To serve customer expectations of continuous access to electricity, a collection of generators, towers, wires, transformers, switches, and poles were erected and stitched together. The U.S. electric power system is typically divided into the categories of generation, transmission, distribution, and end-use.

In addition to the physical infrastructure, a centralized control paradigm was developed in which large remote generators are coordinated and dispatched to support the reliable delivery of electricity to end-users through a vast network of high-voltage transmission lines and lower-voltage distribution systems. System operators have been tasked with the dispatch of generators to meet all dynamic demands while ensuring reliability and minimizing costs, a process known as security-constrained economic dispatch.

Parts of the electric grid are more than a century old, and 70 percent of the transmission lines and large power transformers are more than 25 years old [2], [3]. Along with aged assets, the electric power system is evolving from one consisting predominantly of dispatchable generation sources (e.g. coal, natural gas, and hydroelectric) to one having increasing percentages of variable generation sources (e.g., wind and solar). The penetration of variable and intermittent generation varies widely across the United States, as does the ability of the regional grids to accommodate them. Additionally, the centralized control paradigm in which generation is dispatched to serve variable customer demand is being challenged with greater deployment of distributed energy resources (DERs). The increasing adoption of electric vehicles will also introduce demand growth on variable locations across the grid. These broad system changes have created a need for advanced solutions to help solve modern operational challenges and address the limitations and risks associated with aged infrastructure.

Ultimately, the goal of the electric grid is to deliver safe, reliable, and cost-effective electric power. For each part of the system, there are numerous tools, technologies, and approaches to



help accomplish this goal. In the distribution system, vegetation management and distribution automation are used to prevent and recover from interruptions. In the transmission system, a variety of contingencies are analyzed and planned for while phasor measurement units provide wide-area situational awareness. Advanced transmission technologies (e.g., dynamic line rating, transmission monitoring, topology optimization, power flow controllers) are a suite of tools that can help address transmission challenges from an evolving grid, improving the efficiency and effectiveness of electricity delivery, and increasing the reliability and resilience of the system. Other technologies, such as energy storage, microgrids, and distributed controls, can also help support the overall objectives of the electric power system.

## Electric Grid Challenges

The U.S. electric grid contains more than 642,000 miles of high-voltage transmission lines and roughly 6.3 million miles of local distribution lines that operate within a patchwork of federal, state, tribal, and local regulatory jurisdictions [4]. The reliability of the bulk-power system (i.e., the facilities and control systems necessary for operating an interconnected electric transmission network and the electric generation facilities needed to maintain system reliability) generally falls under the purview of the Federal Energy Regulatory Commission (FERC) and the North American Electric Reliability Corporation (NERC), which develop, issue, and enforce mandatory reliability standards [5].

Several professional organizations, such as the Institute for Electrical and Electronics Engineers (IEEE), International Electrotechnical Commission (IEC), and the International Council on Large Electric Systems (CIGRE), also issue guidelines and technical standards. These various standards provide the basis for the bulk-power system that is key to ensuring the safe and reliable delivery of electricity. However, these standards also result in constraints on the power system that might be slow to adapt to changing conditions.

Several key electric grid challenges affecting transmission systems today include:

**Limited transmission capacity.** The physics of the power system and underlying material properties restricts the maximum delivery capacity or “demand ability” of a transmission line by a thermal limit, a voltage limit, and a stability limit. Thermal limits are set to ensure transmission lines do not sag excessively or burn in an underground pipe type system and are determined by the conductor temperature limit. Voltage limits are set to maintain that voltage drops across the length of a line are not overly excessive (less than five percent) and are generally influenced by the reactance of the conductor. Stability limits are set to provide a safety margin (30 percent of maximum power) to ensure that the system remains stable during gradual changes and contingencies and are influenced by the impedance of the line. Generally, the load-carrying ability or ratings of short transmission lines (less than 50 miles) are thermally limited, medium-length lines (between 50 and 200 miles) are voltage limited, and long lines (over 200 miles) are stability limited.

Traditional solutions to increasing transmission capacity include expanding, upgrading, or rebuilding the electric infrastructure. Investments in transmission expansion projects in the United States have increased in value every year since 2014 and totaled over \$20 billion in 2016 [6]. Because most transmission infrastructure was built between the 1960s and the 1980s, these investments are needed to sustain grid reliability as the assets age. One estimate projects that transmission replacement costs alone will increase by \$1.2–\$3.2 billion per year over the next ten years, assuming facilities need to be replaced after 60 to 80 years of operation [7]. Additionally, line re-conductors with high temperature, low sag conductors, which can be used in some situations to increase capacity on existing transmission rights-of-way (ROW), can cost from \$1 million to \$8 million per mile depending on the voltage class of the line [8].

**System congestion.** If a transmission system component, such as an overhead line or a substation, is operating at its physical limit (as discussed above), system operators may choose to run a more expensive generator on the downstream side over a less expensive one on the upstream side to de-load the components by injecting power on the downstream of the power flow and meet safety and system reliability standards. The events and costs associated with the suboptimal commitment and dispatch of generators are known as congestion [9]. Grid operators attempt to mitigate congestion by forecasting demand and generator availability in the short term (e.g., through day-ahead and hour-ahead markets), planning around maintenance schedules and line outages in the mid-term, and identifying system needs in the long term (e.g., through multiyear resource, transmission, and distribution planning). Congestion costs can be quite substantial; between 2009 and 2017, California ratepayers' bills included \$683.5 million in congestion-related costs [10]. According to a 2018 U.S. Department of Energy report, the sum of real-time congestion costs for 2016 among major system operators—specifically, the California Independent System Operator (CAISO), the Electric Reliability Council of Texas (ERCOT), Independent System Operator New England (ISO-NE), Midcontinent Independent System Operator (MISO), the New York Independent System Operator (NYISO), and PJM—was \$4.8 billion [11].

**Increased variability and uncertainty.** The demand for electricity changes by the minute, hour, day of the week, and season with times of peak demand varying by region. Generally, economic activity drives these variations (e.g., residential demand drops during work hours, commercial or industrial demand decreases on non-office hours or weekends) but is augmented by weather, seasonal, and regional factors. In hot climates, home air-conditioning usage increases the overall demand in the late afternoons during the hottest part of the year. In cold climates, home heating using electricity increases in mid-mornings and mid-evenings during the coldest part of the year. Dispatching generation to meet time-varying demands across the entire United States while considering transmission constraints is challenging and a noteworthy achievement by industry personnel. The increased variability and uncertainty introduced by renewable resources and DERs is making this real-time balancing act much more difficult.

As these new renewable resources increase in penetration, changes in power flows to meet the system needs will occur on a much faster time scale. System operators will struggle to keep pace with the decision making needed to balance the system without introducing larger safety margins. Additionally, optimizing dispatch to manage congestion and other issues will be much more difficult with the increased uncertainty.

**Threats and vulnerabilities.** Under NERC reliability rules, a power system must be operated so that it will remain stable despite the instantaneous loss of any single transmission line or generator (i.e., N-1 contingent). Grid operators and planners manage the system by ensuring that there is enough spare capacity on transmission lines and other equipment so that a single contingency will not overload them. Large-scale events, unplanned events, or emerging threats can result in multiple contingencies. In the event of overloads, relay settings may trigger protective actions that can lead to interruptions or outages. Cascading failures of transmission lines due to overloading contributed to the August 2003 blackout in the northeastern United States.

Numerous power system events can cause disruptions, including component failure, human error, seasonal weather events, and damage—either unintentional or willful. These risks typically can be managed by robust training, drilling, planning and emergency response procedures, effective maintenance, and overall preparedness. New threats and vulnerabilities are emerging, such as cyber-attacks, extreme weather events, pandemics, wildfires, and terrorist attacks, which introduce new challenges to system operator and planner decision making. The tools, reliability rules, and options available today might not suffice to prevent or minimize outages or recover from such events.

## Advanced Transmission Technologies

Several advanced transmission technologies exist today that can be used to improve and enhance the transmission system, spanning both grid software and grid hardware, as defined in Figure 1. Sensor and software solutions, such as dynamic line rating and topology optimization, focus on improvements in the control center, control systems, and decision-making processes. Actuator and hardware solutions, such as power flow controllers and advanced conductors and cables, focus on improvements in the physical assets and infrastructure responsible for carrying, converting, or controlling electricity. These different technologies can be used in isolation or in tandem to improve the overall efficiency and effectiveness of the transmission network. These technologies can also help increase the reliability and resilience of the entire electric power system.

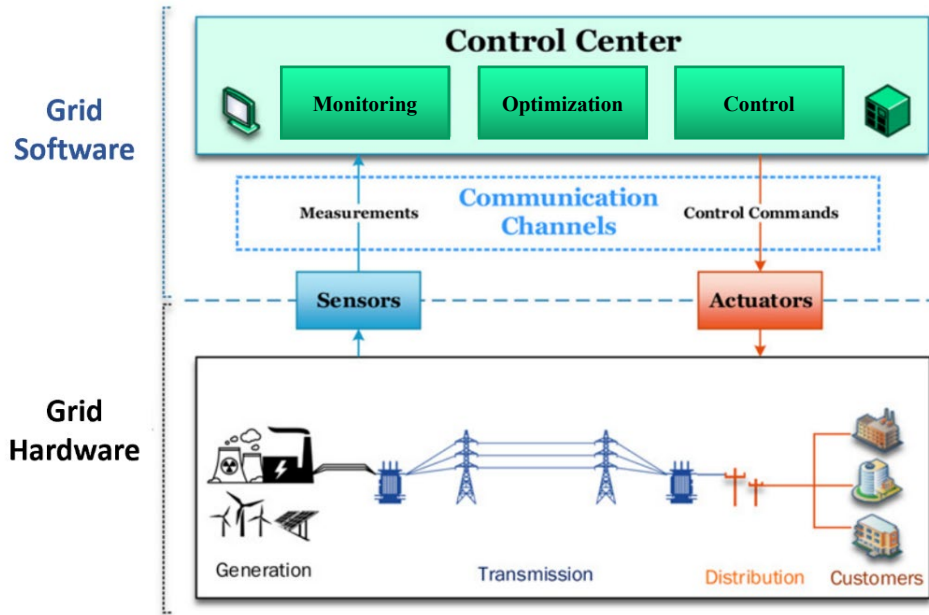

**Figure 1. The modern grid: An integrated system comprising grid software and grid hardware.**

Source: Adapted from <https://ieeexplore.ieee.org/stamp/stamp.jsp?arnumber=7805372>. [12]

**Efficiency and effectiveness.** Technologies, tools, and methods that help manage congestion and defer transmission upgrades will increase the effective and efficient use of resources and installed equipment.

This is especially true when transmission capacity is needed to access low-cost variable renewable resources and new lines are increasingly difficult to build due to siting and permitting challenges. Additionally, technologies that reduce energy losses and minimize the amount of reserves needed to meet system reliability requirements will also improve economic efficiency. In most cases, the ability to increase transmission capacity by removing constraints, maximizing existing ROW, or by enabling new grid access will increase the effectiveness of delivery to meet societal needs. For example, new solutions are needed to meet demand growth from electric vehicles charging, especially in densely populated areas with little to no room for new transmission and distribution infrastructure.

**Reliability and resilience.** FERC has stated it understands resilience to mean “[t]he ability to withstand and reduce the magnitude and duration of disruptive events, which includes the capability to anticipate, absorb, adapt to, and rapidly recover from such an event [13].” Technologies, tools, and methods that help improve situational awareness, increase flexibility and responsiveness, and enhance the grid’s ability to better handle uncertainty and unforeseen circumstances will increase reliability and resilience. Generally, capabilities that help monitor and respond to real-time conditions are foundational to ensuring reliability. These capabilities can also bolster resilience if they are able to perform in emergency and unplanned situations. While better data and analytics can improve decision making before, during, and after a contingency or system event, the ability to actively control the flow of power provides many new opportunities. For example, extreme events that result in outages tend to have limited

geographic scope; enabling more power to be imported into a region from neighboring areas that are less affected by the event can accelerate recovery. In cases where a customer's supply might normally be disrupted to maintain system stability, active power control can provide a means to avoid an outage, increasing reliability.

### III. Sensors and Software Solutions

Sensors and software solutions focus on improving the operations and planning of the grid while working within the constraints of the physical hardware. These technologies generally improve upon a short-term system outlook, such as day-ahead or real-time applications, rather than a longer-term planning horizon. Long-term system planning seeks to find an optimal transmission expansion plan with optimum aggregate benefits over the planning horizon. A well-planned network can still benefit from these solutions in the short-term since real-time network conditions will frequently differ from assumptions used in long-term planning. This section will discuss the opportunities and specific barriers for dynamic line rating and topology optimization.

#### Dynamic Line Rating

Line ratings have been an important tool in determining the current-carrying capacity of transmission lines for over 80 years. More refined approaches using data on environmental conditions have given operators greater ability to fully utilize capacity on transmission networks. Dynamic line ratings (DLRs)—the latest iteration—provide system operators with real-time data to aid decision making, helping to manage congestion and improve situational awareness.

Static line ratings, developed in the 1930s, set the maximum current-carrying capacity based on conservative assumptions with regard to environmental parameters [14]. Seasonal line ratings (SLRs) that reflect changes in average temperature across seasons and ambient adjusted ratings (AARs) that reflect changes in daily temperatures were later introduced. In the 1970s, initial attempts were made to provide daily and hourly ratings [15]. In the 1990s, DLRs based on real-time monitoring systems were developed that could unlock 10–25 percent of additional line capacity [16]. However, these first-generation DLR systems had several underlying issues, including complex installation and inconsistent measurements, which discouraged wider adoption. Subsequent generations are being developed to address these shortcomings.

Generally, a DLR system includes: sensors mounted on or near the transmission line to be observed; a communication system that relays information from field sensors to the control room; a DLR analytic engine for processing and validating the data; and interfaces with energy management systems (EMSs), supervisory control and data acquisition (SCADA) systems, and operators to inform decisions (Figure 2). Sensors monitor, measure, and transmit data on line conditions and ambient conditions that determine the maximum current-carrying capacity of the line in real-time. Information could include the temperature of the line, tension on the line, line sag (or clearance to ground), ambient temperature, wind speed, and wind direction. Direct conductor monitoring typically results in better accuracy and precision than ambient

monitoring alone. However, this method requires many sensors to be installed on the transmission line to support adequate coverage, which increases costs.

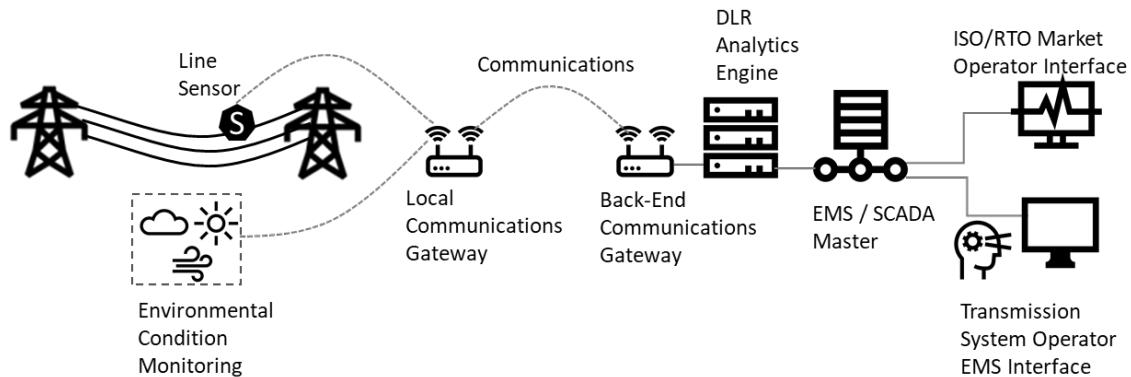

*Figure 2. Conceptual DLR system.*

Numerous pilot projects that have implemented DLR across the United States, Canada, and Europe have demonstrated benefits. More detailed information on DLR and these projects can be found in Section VII. Appendix – Dynamic Line Rating and in the 2019 Report on Dynamic Line Rating [17].

### Opportunities

**Congestion relief.** DLRs can be a cost-effective method for mitigating congestion. For example, a study of PJM showed that a \$500,000 DLR solution on the 345-kV Cook-to-Olive transmission line between Michigan and Illinois could provide annual congestion cost savings of more than \$4 million [18]. In comparison, the cost of a traditional transmission system upgrade to alleviate this congestion would have been between \$22 million and \$176 million, making the DLR solution a fraction of the cost.<sup>a</sup> Assuming this result can be replicated across regions of the country with ISO or RTO markets, the benefits would be approximately \$240 million in annual congestion cost savings.<sup>b</sup>

Similarly, a study in Southwest Power Pool (SPP) projected cost savings of \$18,000 over 300 minutes of congestion [19]. Assuming this level of congestion persists for ten percent of the year and the level of impacts from DLR are similar, the benefits would be equivalent to cost savings of over \$3 million from a single project. For reference, nine of the top ten constrained transmission elements in SPP were congested between approximately seven percent and 30 percent of the time in the day-ahead market in 2018 [20].

<sup>a</sup> This comparison focuses specifically on the benefits from congestion relief. A traditional transmission solution could provide other benefits depending on the type of upgrade implemented.

<sup>b</sup> Annual congestion cost for six of the major ISO/RTO regions is estimated at \$4.8 billion in 2016 [17]. The estimate of \$240 million is 5 percent of \$4.8 billion. The six major regions included here are CAISO, ERCOT, ISO-NE, MISO, NYISO, and PJM. This calculation is intended to demonstrate the order of magnitude of benefits. Different regions calculate congestion costs differently.

**Improve situational awareness.** DLR provides more accurate information on line conditions to support system operator decision making. This improvement can be critical in situations where lines may sag below clearances and make the system vulnerable to faults and safety hazards. For example, DLR can detect when actual line ratings are lower than ratings calculated from static methods as shown in Figure 3. This occurs infrequently, such as during a very hot day with no wind and high solar exposure. When it does occur, DLR can assist system operators in mitigating risks by identifying lines loaded beyond real-time capability.

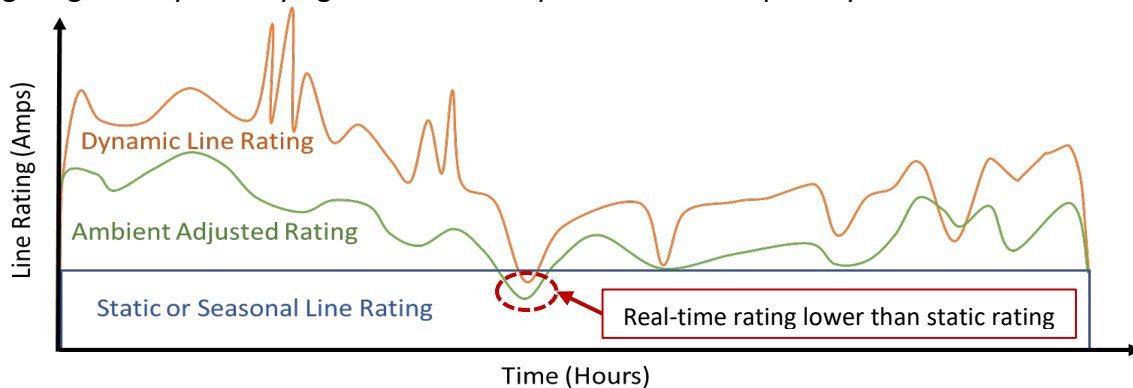

*Figure 3. Illustrative example comparing potential difference results from alternative line rating methods.*

By keeping lines from being overloaded, system operators can increase reliability as well as protect the public from consequent issues of safety (e.g., fire or electric shock). For example, DLR can identify power lines at risk of causing sparks that can lead to fires [21]. DLR systems alone cannot avoid wildfires, but they are part of a broader solution that can provide the data to assist in wildfire prevention strategies, including methods to operate the grid and timing on clearing vegetation, and to upgrading equipment.

**Proactive asset health monitoring.** DLR can provide greater insight into the performance of a line over time. Rather than relying on engineering assumptions and maintenance schedules, real-time status of the line can be used in decision making to mitigate component failures, boosting reliability. Mining the sensor data with enhanced analytics can help detect anomalies and deliver alerts when conditions are observed that indicate a risk to reliability or public safety. DLR can also improve reliability by informing relay settings used to protect transmission equipment [8], providing timely updates as the system changes.

**Increased operational flexibility.** Transmission owners occasionally increase the static rating of a transmission line if requested by an ISO/RTO under unique circumstances. DLRs that support more power to be imported into a region during an outage event can increase grid reliability and resilience. The increased operational flexibility would be beneficial during certain extreme weather conditions, such as the 2018 “bomb cyclone” and the 2014 “polar vortex” events [22] [23]. During these events, extremely low temperatures and wind chill caused high electricity demand, equipment failures and fuel supply constraints that resulted in generators being taken out of service. DLR would provide grid operators the option and ability to take advantage of the fact that colder temperatures and high winds allow for increased capacity on transmission

lines [17]. In general, DLR can support more electricity delivery options during a disruption and mitigate demand interruptions, and it can also facilitate recovery and restoration after an event.

#### Specific Barriers

**Cost to benefit.** Past studies have shown that DLR systems were able to increase line capacity from ten percent to 70 percent of the static rating. Studies also indicate that capacity increases over AAR are more modest and highlight the importance of evaluating the cost-effectiveness of DLR relative to AAR. It is also important not to overestimate the potential for DLR in a region. The addressable market for DLR is often discussed in connection with the total congestion costs in a system, but DLR can only offset a fraction of those costs. DLR affects only the thermal limits of a line; it is ineffective for lines with voltage or stability constraints, which usually result in lower limits than the thermal rating. Additionally, because of the interconnected nature of the grid, implementing DLR to alleviate congestion on a line or group of lines might shift the point of constraint downstream to other connected lines, limiting effectiveness.

**Existing markets.** Existing market rules and operating constructs may be hindering the greater use of DLR in the United States. All seven independent system operator (ISO)/regional transmission organization (RTO) systems and their associated markets either currently use or can accept AAR, whereas only two use DLR and AAR for day-ahead market operations.<sup>c</sup> Figure 4 shows the most common line rating method for each ISO/RTO, as well as the capability for each entity to accept DLR or AAR into their control center. Making changes to control systems and market operations can be expensive, and the remaining ISO/RTOs may not be willing to make the technological investments needed to support greater use of DLR.

---

<sup>c</sup> The seven ISO/RTO systems are the California Independent System Operator (CAISO), the Electricity Reliability Council of Texas (ERCOT), Independent System Operator New England (ISO-NE), Midcontinent Independent System Operator (MISO), New York Independent System Operator (NYISO), PJM Interconnection (PJM), and Southwest Power Pool (SPP).



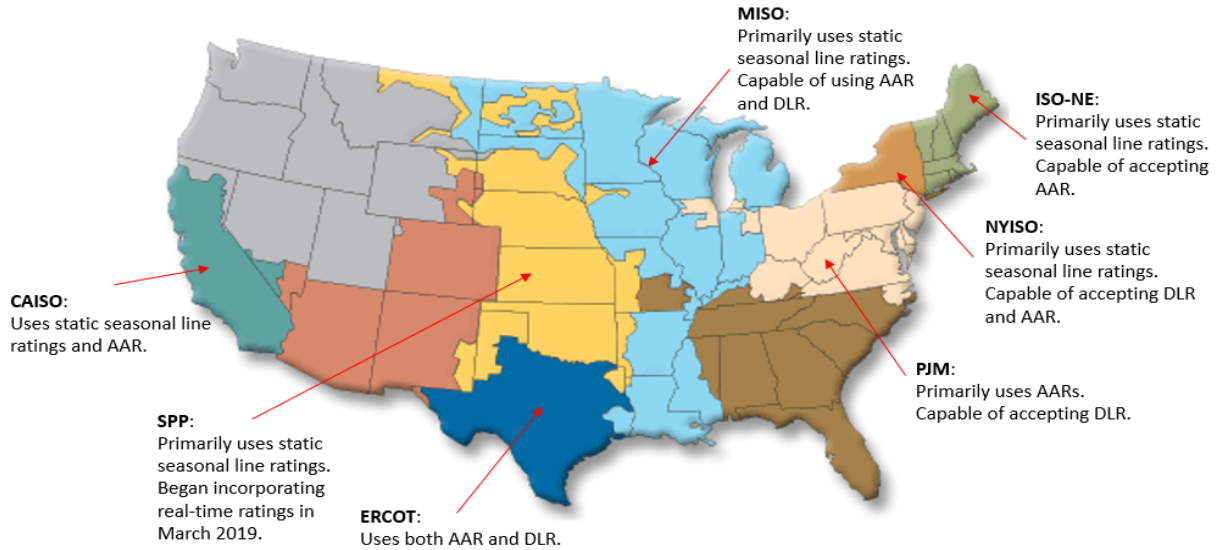

**Figure 4. ISO/RTO primary line rating method and capability.**

Source: Adapted from <https://www.ferc.gov/market-assessments/mkt-electric/overview.asp>. [24]

**Insufficient incentives.** Under the current cost-of-service regulatory structure, transmission owners receive a rate of return on capital investments for infrastructure projects. Larger and more expensive projects will naturally return more than smaller investments. Such projects also do not receive a return on O&M expenditures. This could further reduce the attractiveness of DLR investments because DLR is likely to include some costs classified as O&M expenses, which would effectively reduce potential transmission owner profits relative to alternative capital investments [17]. In addition, the benefits of avoided congestion costs flow directly to end-use electric customers, which further reduce the economic incentive for transmission owners to proactively investigate and deploy DLR technology.

**Measurement and modeling errors.** Measurement and modeling errors can affect the accuracy of DLR calculations and reduce confidence in the technology, limiting adoption. Measurement errors include imprecise or inconsistent measurements and improperly calibrated sensors. Modeling errors include inaccurate mathematical models, weather forecasting errors, and data collection errors. Another source of error can come from insufficient sensor deployments. If the DLR system does not cover the most limiting span of the transmission line, values calculated could overstate the actual rating of the line. A potential strategy to mitigate these various errors is to incorporate confidence levels into the DLR calculation and rate lines more conservatively when confidence levels are low [17].

**Other system limitations.** In some cases, the maximum current-carrying capacity limit of a transmission line could be based on the rating of substation terminal equipment, which includes relays, current transformers, switches, and circuit breakers. Utilizing DLR to increase line capacity without making upgrades to the limiting elements will render the DLR system ineffective. Conducting equipment assessments and analyzing network power flows can help identify these limiting elements before DLR deployment. Additionally, development and

deployment of low-cost sensors that can monitor the health and status of other terminal equipment can augment transmission line information to identify true capacity limitations. [25]

## Topology Optimization

The transmission network is built with redundancy to meet and address mandatory reliability standards under worst-case scenarios. While these redundancies support system reliability during specific operating conditions, they might not be needed during other operating periods and could create dispatch inefficiencies. Consequently, it might be possible to temporarily remove a line from service under certain operating conditions and improve overall system efficiency without jeopardizing reliability.

Topology control refers to the real-time switching of transmission branch elements, such as transmission lines and transformers, through the opening and closing of circuit breakers to redirect power flows.<sup>d</sup> Traditionally, real-time congestion management involves the re-dispatch of upstream generation resources. Topology optimization, an application of topology control, augments this method by including transmission infrastructure as a dispatchable asset to optimize to minimize congestion.

Topology control has been studied since the early 1980s and, while often impractical, may be used by system operators in certain emergency conditions as a corrective mechanism to address reliability concerns [26] [27]. For example, transmission line switching may be used as a last resort by system operators to eliminate voltage violations (i.e., voltage levels that are too high) during lightly loaded hours [28] [29]. Utilities and system operators have also used corrective switching to maintain system reliability following a disturbance. These actions are more generally characterized as Special Protection Schemes (SPS) or Remedial Action Schemes (RAS).<sup>e</sup> Although an important tool for maintaining reliability, these schemes essentially function as look-up tables. The solutions developed are based on sets of assumed system conditions and are inherently limited by those conditions' pre-defined nature. These solutions are not necessarily optimized and might be unable to handle new or unforeseen conditions.

Current topology control methods are based on system operator expertise and time-consuming manual processes to identify switching candidates ahead of time. These documented switching actions must still be evaluated under real-time conditions so as to not result in unintended consequences. Recent development of tools, including artificial intelligence, that can systematically and automatically identify optimal transmission control actions have enabled topology optimization to emerge as a viable solution to address transmission challenges. An example of how topology optimization software can integrate with transmission operator

---

<sup>d</sup> A transmission line is switched into the network by placing it in service or energizing it. It is switched out of the network by taking it out of service or de-energizing it. Topology refers to the arrangement of transmission branch elements in the network. Transmission line switching changes the arrangement of lines that can supply power.

<sup>e</sup> SPS and RAS refer to protection schemes that are designed to automatically detect abnormal or predetermined system conditions and take predetermined corrective action to counteract the observed condition in a controlled manner to maintain system reliability.

decision making is shown in [Figure 5](#). The software can automatically provide the system’s current state from existing operator tools, evaluate switching options, and present possible actions to the system operator as another means to mitigate abnormal conditions. More information on available topology optimization software can be found in Section VII. Appendix – Topology Optimization.

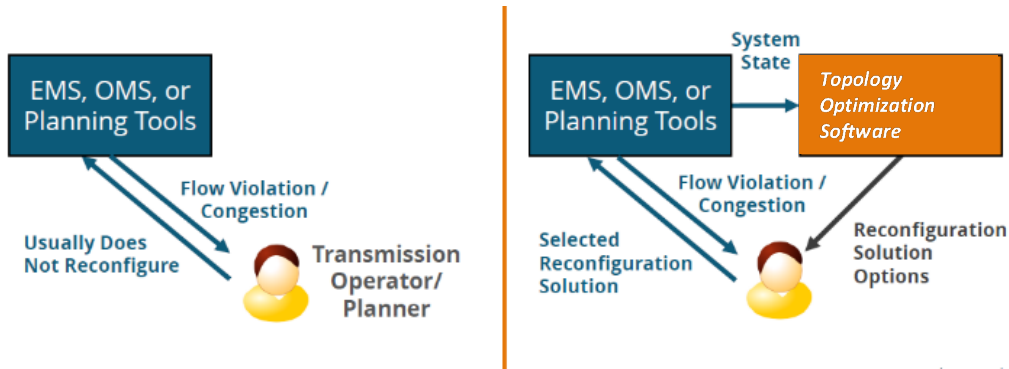

**Figure 5. Topology optimization integrates with operator/planner decision making.**

Source: Adapted from "Transmission Topology Optimization: A Software Solution for Improving Congestion Management" (slide 5); <https://www.esiq.energy/event/webinar-transmission-topology-optimization-a-software-solution-for-improving-congestion-management> [30]

### Opportunities

**Congestion relief.** Early research on topology optimization showed the potential for up to 25 percent production cost savings,<sup>f</sup> but is reduced to 16 percent when ensuring reliability (i.e., meeting N-1 criteria) of the proposed solution [31]. In an SPP pilot, topology optimization was used to relieve congestion observed on transmission lines downstream from wind resources as shown in [Figure 6](#) [32]. In this case, excessive wind generation was creating real-time transmission congestion resulting in 285 megawatts (MW) of wind curtailment. The software was able to identify three switching actions that diverted power flows around the congested elements and provided enough relief to avoid the need for any wind curtailments, reducing price and overall production costs.

<sup>f</sup> Production cost refers to the fuel and non-fuel costs incurred to produce electricity to meet demand, subject to system constraints. Non-fuel costs include operation and maintenance costs and environmental costs (such as the cost to purchase emission allowances). Production cost savings are derived from the ability to use generation resources more efficiently. System improvements that relieve constraints and increase the use of relatively cheaper generation resources or reduce the use of relatively more expensive generation can reduce total production cost and provide production cost savings. Production costs are different from electricity market prices. Market prices are based on the marginal cost of generation; that is, the incremental cost to produce an additional unit of electricity. Market prices are also subject to system constraints.

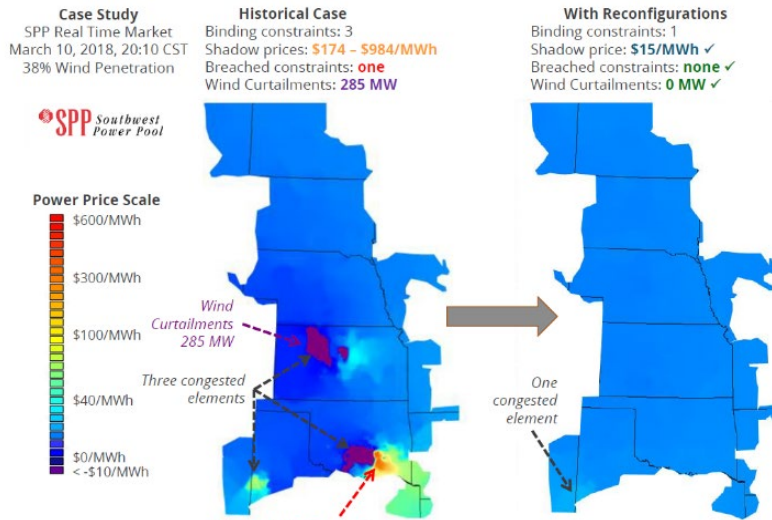

**Figure 6. Congestion and wind curtailment relief using topology optimization.**

Source: Adapted from “Transmission topology optimization: pilot study to support congestion management and ice buildup mitigation” (slide 6); [http://newgridinc.com/wp-content/uploads/2018/11/Topology-Optimization\\_SPP-Technology-Expo\\_20181115\\_FINAL.pdf](http://newgridinc.com/wp-content/uploads/2018/11/Topology-Optimization_SPP-Technology-Expo_20181115_FINAL.pdf) [33]

In a study of PJM, the topology optimization software was able to identify reconfiguration actions that resulted in a 50 percent reduction in real-time congestion costs, which extrapolates to an estimated PJM-wide annual production cost savings of over \$100 million [34]. Another study with SPP estimated real-time market savings to be three percent of the congestion costs, on average. Historical data show that the annual real-time market savings for SPP was extrapolated to be between \$18–44 million when used with market optimization [14] [35]. In the United Kingdom, National Grid investigated the feasibility of adopting topology optimization using line switching, substation reconfiguration, and alternative settings for phase-shifting transformers. The solutions found increased the transfer capability on thermally-limited lines by as much as 12.3 percent, which could lead to estimated annual cost savings of £40 million (approximately \$50 million) [36] [37].

**Improved operations and planning.** Topology optimization can be used when responding to contingencies to help eliminate overloads and violations, minimizing outages and increasing reliability. A study estimated that topology optimization can reduce the frequency of system violations by at least 75 percent without incurring additional costs [32]. The software can quickly and automatically identify optimal corrective actions given the altered operating state, which can also increase resilience. For example, following severe weather events or other high-impact, low-frequency events, topology optimization can provide various options to accelerate system recovery while minimizing customer interruptions or disconnections. The technology can also be used to improve outage scheduling and coordination, enabling options that otherwise would lead to reliability violations or increases in congestion. In addition, the software can mitigate adverse impacts if real-time system conditions change during a planned outage.

SPP implemented a pilot project to identify reconfiguration solutions to previously observed transmission overload [32]. Several solutions identified were used to develop new operating guides for system operators.<sup>8</sup> In one instance, real-time operation staff requested support from the topology optimization software to assess post-contingency overloads. The software quickly identified a pre-contingency mitigation plan that reduced the power flow constraint by more than 20 percent and eliminated the post-contingency overloads. SPP also used the software to investigate switching solutions to mitigate demand curtailments. For all three events considered, the software found corrective reconfigurations that relieved the flow violations without load shedding and did not cause any other violations [32].

**Economic value.** Topology optimization does not require installation of new hardware, thus reducing implementation costs. By leveraging existing transmission system infrastructure and communications hardware, the technology can be deployed quickly and integrated easily with existing systems. Although topology optimization is more applicable in the real-time operations and operations planning environment, it could also be used to increase the value of system expansion plans. For example, the increased flexibility from using topology switching can increase the long-term value of transmission upgrades and should be considered when making infrastructure investment decisions. Within the near-term planning horizon, topology optimization might also help to defer some transmission line upgrades.

#### Specific Barriers

**Computational complexity.** Most approaches to topology optimization recharacterize transmission branches as controllable assets capable of being optimized within the context of the optimal power flow problem [38] [39]. While this might be feasible in a small system with limited elements, this optimization problem becomes computationally intensive and much more complicated when considering the size of U.S. power grids. With the large set of potential line switching combinations, it becomes extremely difficult to identify optimal topologies quickly enough for topology optimization to be effective in real-time operations.

Many researchers have presented approximations and other simplifications to reduce the complexity of these calculations. However, there is a risk that oversimplifying the problem will negatively affect the accuracy of results, potentially jeopardizing reliability. Application of high-performance computing can also help reduce computation times but will come at added cost. Research toward improving the computational performance of optimal transmission switching algorithms is ongoing [40]. Until these issues are more fully addressed, it will be difficult to integrate topology optimization into real-time grid operating systems.

---

<sup>8</sup> Operating guides contain instructions to execute predefined transmission system actions, such as the previously defined SPS or RAS, in response to various system conditions to prevent or resolve transmission security violations.

**Existing markets.** The effect of topology optimization on existing markets can be a barrier to adoption because topology optimization undermines the prevailing market assumption that the transmission grid is a static asset. For example, the day-ahead Financial Transmission Rights (FTR) market requires this assumption to operate as designed [41].<sup>h</sup> Transmission outages (including from switching actions) can lead to financial shortfalls if not modeled in the FTR allocation and auction. Market participants will need to adapt to consider a more active role by the market operator, if topology optimization were to be used. Mitigations for these consequences have been proposed, including considering revenue adequacy as a constraint in the topology optimization software, or possibly a redesign of the FTR market such that the flexibility of the network can be accounted for in the FTR auction [42]. More research is needed to thoroughly examine options and affected parties can participate in these developments via an open process.

**Hardware impacts.** To support reliability, utilities and system operators rely on circuit breakers to operate as expected and when directed. Implementation of topology optimization will cause circuit breakers to operate more frequently, which will accelerate aging, increase maintenance costs, and affect component reliability. Circuit breaker performance and longevity depend on several factors, including switching rates, the number of switching operations, and current magnitudes during switching events. These factors can be incorporated into the software to limit the list of switching candidates and as another parameter to optimize. More research is necessary to quantify the effect and costs associated with increased breaker operation to better inform operator decision making. Accurately and completely quantifying circuit breaker maintenance and replacement costs is needed to support greater adoption of topology optimization.

**System impacts.** Switching operations, such as those associated with topology optimization, can create disturbances that compromise the stability of the grid. Power system instabilities can lead to cascading failures—and ultimately blackouts—if not properly managed. Research on the effects of transmission line switching has shown that the system will remain stable during normal operations and following a contingency with properly tuned, conventional controls present in the system [43] [44]. However, as the power system changes with greater deployment of inverter-based resources (e.g., wind, solar, batteries), ensuring that all these controllers are properly tuned may not be trivial and will require investigation. Additionally, advances in power system modeling tools that can assess system stability, explore controller interactions, and system transients are needed to help alleviate concerns. System operators and planners can use these tools to confirm system stability under proposed reconfiguration solutions offline and before applying the switching action(s).

---

<sup>h</sup> FTRs are financial instruments for market participants to bet on local price differences in the day-ahead market, which arise because of the limited capacity of the transmission lines. The holder of an FTR is entitled to a stream of revenue based on the hourly, day-ahead congestion prices between a specified source and sink. This is a method for the holder to hedge congestion costs.

## IV. Actuators and Hardware Solutions

Actuators and hardware solutions focus on increasing the physical capabilities of the underlying grid infrastructure, and addressing the thermal, voltage, and stability limits that constrain the transmission system. These technologies are generally more capital intensive than sensor and software solutions and improve the long-term reliability and resilience of the grid. This section will discuss the opportunities and specific barriers for power flow controllers, both alternating current (AC) and direct current (DC) technologies, as well as advanced conductors and cables.<sup>i</sup>

### Power Flow Controllers: Alternating Current Technologies

Power flow controllers (PFCs) are a family of technologies that can actively change the way power flows through the transmission system without making changes to generator dispatch or the topology of the network. The AC power flowing on a given transmission line is driven by four key parameters based on physics of the power system: the voltage on each end of the line, the reactance of the line, and the voltage phase angle difference between both ends. AC PFCs operate by adjusting one or more of these parameters.

PFC technologies have existed since the early 1900s, with the earliest being phase-shifting transformers (also referred to as phase angle regulators [PARs]) and tap-changing transformers. The main drawbacks of these mechanically switched devices are the slow response and coarse level of control (functionally, these devices can only be operated in discrete steps). PFC technologies based on solid state switches (i.e., power electronics) were introduced in the 1970s and called flexible AC transmission systems (FACTS). FACTS devices offer fast and dynamic compensation to allow more power to be transferred on a transmission line and support the stability of the grid. Newer FACTS devices that use more advanced power electronic switches, such as the unified power flow controller (UPFC), offer greater flexibility and control capabilities but have seen limited deployments due to costs.

Many different AC PFCs are still in use today, especially the tap-changing transformer. There are currently five PARs on the Michigan-Ontario power line to counter loop-flows around Lake Erie, the first unit having been installed in 1975 [45]. In 1998, American Electric Power deployed UPFCs on the transmission system in the Inez area to combat high power losses. These devices added 770 MW of capacity to the system, whereas a new line would have only added 670 MW of power transfer capability. In 2016, the New York Power Authority completed the Marcy South Series Compensation Project, which installed three capacitor banks to expand transmission capacity by 440 MW [46]. FACTS devices are also becoming increasingly important for the integration of variable renewable resources in “weak” systems to support stability.

---

<sup>i</sup> Electric power systems primarily operate with alternating current and voltages due to the ability to readily transform between voltages in order to interconnect generation, delivery, and end use. However, there are strategic advantages for using direct current and voltages, including improved efficiency and better control.

DOE is supporting the development of new AC PFC technologies to enhance control capabilities while reducing costs [47] [48]. One example is the distributed series reactor (DSR) technology in which multiple small, modular devices are installed along a transmission line to provide the same capability as a single, larger system. This distributed approach makes it more cost-effective and easier to deploy than other PFC technologies that require installation within a substation. Figure 7 shows the operating concept for DSRs where system operators change line reactance through a series of communication and control technologies. More information about AC PFC technologies can be found in the Appendix.

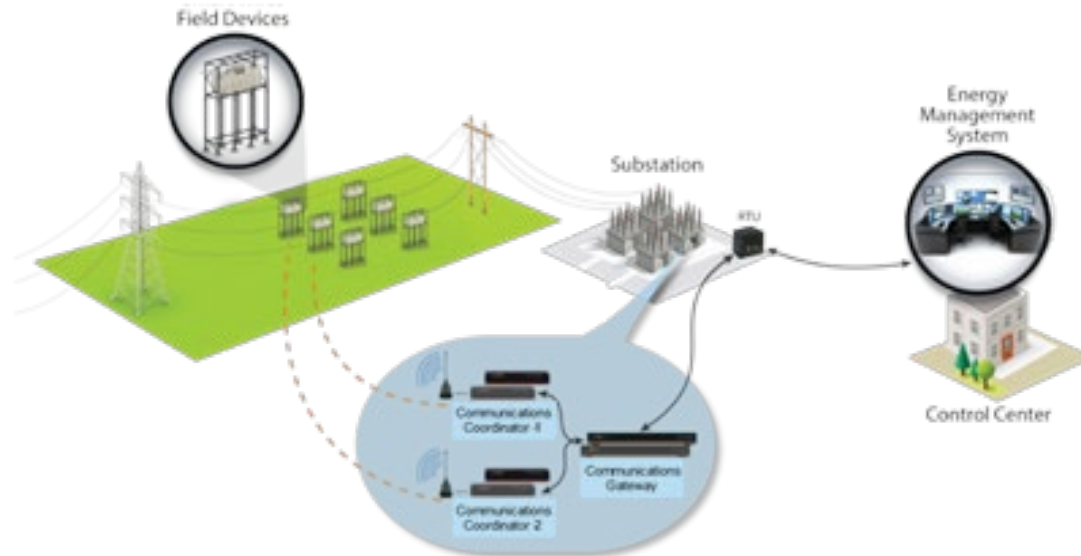

**Figure 7. Distributed DSR communication and control system.**

Source: Adapted from <https://www.smartwires.com/smartvalve/> [49]

### Opportunities

**Congestion relief.** Active control of power flows provides more flexibility to manage congestion than do passive measures. A study of PJM with novel PFC technologies examined how economic benefits varied with the number and size of phase angle controllers (PACs) installed [50]. The modeling could only examine congestion from thermal limits due to the complexity of evaluating constraints that arise from voltage and stability limits. As shown in [Figure 8](#), the estimated annual congestion cost savings ranged from \$39 million with a single device (total size of 36 MVA) to \$196 million with 17 devices (total size of 2116.5 MVA) installed at strategic locations. Diminishing returns can also be seen with PACs installed beyond approximately 13 devices (total size of 1426.5 MVA). These savings indicated a payback period of less than three years using assumed costs for the PFC technologies. Additionally, sensitivity analyses showed greater benefits as the amount of renewable penetration increased, which was also the case in scenarios with higher fuel prices.



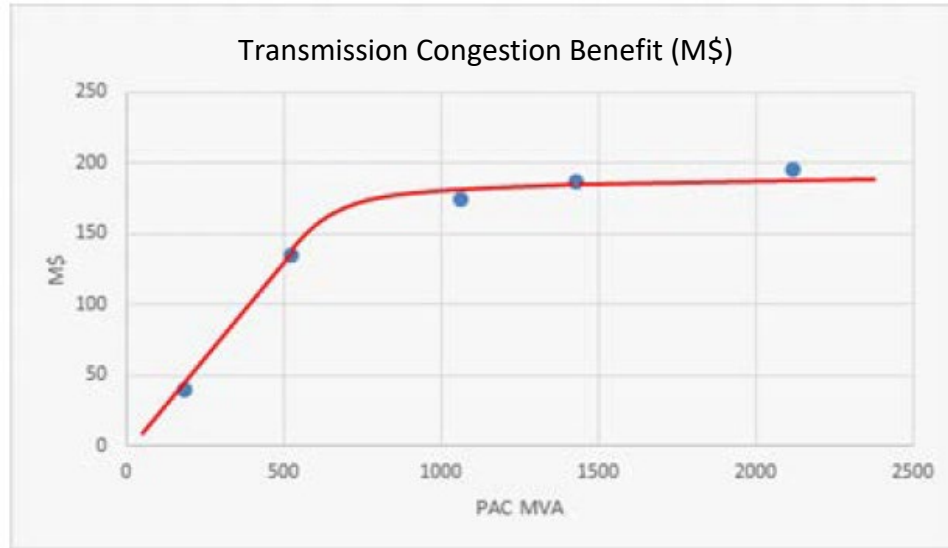

Figure 8. Estimated annual congestion cost savings for 1, 4, 8, 13, and 17 PAC devices in PJM.

Source: Del Rosso, A., Benefits and Value of New Power Flow Controllers, EPRI, 2018. [50]

**Transmission deferral.** Building new transmission infrastructure can be an expensive, time-consuming, and controversial process. PFC technologies can maximize the use of existing assets and defer upgrades in support of more effective and efficient transmission expansion. A study of SPP examined the ability of novel PFCs to resolve line overloads as a way to defer or replace proposed expansion projects [50]. Table 1 summarizes the results of this analysis and compares the cost of the PFC solutions with the original project. In many of the cases examined, the cost of the transmission upgrade is several times the cost of the PFC solution.<sup>j</sup> While these results cannot be generalized due to the specific circumstances of the use cases, the results do provide an indication of the cost-effectiveness of the novel PFC technologies. If the PFC solution is not expected to replace the original proposed project, the benefits can be estimated by comparing the value of deferral.

Table 1. Comparison of PFC and Transmission Solution Costs

Case	Original Project	Original Project Cost	PFC Alternative	PFC Cost Range	Comments
1	New 115-kV line to remove overload at N-1 condition	\$16.8 M	Installation of PFCs on two parallel lines	\$1.5 M–\$5.2 M	Impedance changes necessary to avoid overload change over time. PFCs can be installed gradually over time.
2	Reconductoring 115-kV line and upgrading 230/115 kV substation to address overload caused by transformer outage	\$7.15 M	Installation of PFC on 115-kV line	\$2.4 M	Deferral time greater than 10 years. PFC solution eliminates overload of two system components caused by the same contingency, and can replace the original project.

<sup>j</sup> For the purposes of the study, the PFC and transmission solution are compared only on the ability to resolve the line overloads. New transmission lines can also provide other benefits.

Case	Original Project	Original Project Cost	PFC Alternative	PFC Cost Range	Comments
3	Rebuilding 26 miles of existing 115-kV line	\$14.2 M	Installation of PFC on 115-kV line	\$2.0 M–\$5.0 M	Cumulative value of deferral greater than \$2.0M after year two and greater than \$5.0 M after year five. PFC can be a cost-effective solution if project can be deferred more than two years.
4	Rebuilding 77 miles of 138-kV transmission corridor to address overload due to outage of 345-kV line	\$60.2 M	Installation of PFC on 138-kV line	\$2.4 M–\$3.7 M	Cumulative value of deferral greater than \$4.0 M after first year. PFC can be a cost-effective solution even if deferral time is very short.

Note: The study also examined solutions to a 230-kV line overloaded due to a 345-kV line outage. The cost of the PFC solution was between \$1.12 M and \$4.0 M. No specific project had been identified to resolve the overload, but the PFC could serve as an interim solution while the long-term solution is identified and implemented.

Source: Del Rosso, A., *Benefits and Value of New Power Flow Controllers*, EPRI, 2018.

**Transmission expansion flexibility.** PFC technologies that are modular, such as DSR, are highly mobile, scalable, and can be deployed more rapidly. These features support PFCs to be installed gradually as the system evolves and the need for congestion mitigation arises. In some cases, PFCs can be used to defer conventional solutions until the need is fully established. Additionally, if system conditions change after deployment and the PFC solution is no longer required, the devices could be redeployed to other areas of the system. Transmission expansion flexibility can help improve the efficiency of grid planning and investments and reduce transmission expansion costs.

**Fast and controlled response.** PFC technologies based on advanced power electronic switches can make the grid more flexible and responsive to faults, disturbances, and other unplanned situations. Unlike older PFCs, which provide coarse control, or topology switching, which is either on or off, newer PFCs can better mitigate the effect of transients and other electrical phenomena that can destabilize the grid. The fast and controlled response can improve reliability by quickly and accurately responding to changing conditions and system violations, especially with the loss of system inertia. The increased penetration of variable renewable resources is requiring solutions that can provide reactive power support and other forms of compensation on a time scale consistent with their variability and intermittency.

### Specific Barriers

**Limited deployments.** Advanced PFC technologies face limited deployments because of technology maturity, current costs, and insufficient incentives. The technologies are also limited to overhead transmission systems that have space for equipment and are not well suited for physically restrictive and underground transmission systems. For example, the benefits of avoided congestion flow directly to end-use electric customers, reducing the economic incentive for transmission owners to proactively investigate and deploy PFC technologies. Market and system studies assessing the overall effect of PFC adoption would provide a more comprehensive indication of their PFC value.

Current modeling tools and methods are not sufficient to fully analyze PFC effects on voltage and stability limits. More deployment experience, perhaps through pilot projects, will also be needed to validate the results of these studies and to demonstrate PFC effectiveness in resolving transmission system challenges.

**Existing markets.** As with topology optimization, adoption of PFCs will upend existing electricity markets based on the assumption that transmission infrastructure is static. While a small number of deployments may be feasible under the current structure, greater number of devices will require significant changes. Altering power flows in real-time outside of market operations can lead to financial shortfalls and extra complexity during settlement. Market participants will need to adapt to consider a more active role by the market operator, if PFCs were to be used. Additionally, the integration of PFC capabilities into system models that guide market prices has not been thoroughly investigated. Development of new market mechanisms to accommodate this extra degree of flexibility is needed along with analysis of the respective effects. More research is needed to thoroughly examine options and affected parties can participate in these developments via an open process.

**Established planning processes.** Current transmission planning processes might limit the ability to incorporate PFCs, especially if planners are unfamiliar with how to model or consider the impacts of the technology. Transmission planners are required to plan for worst-case scenarios, such as outages of transmission facilities that could render PFCs ineffective. For example, a PFC solution would not be effective in directing power flows over a transmission path if the path is unavailable due to an unplanned outage [51]. In this regard, the reliability benefits of PFCs could be limited when compared with traditional transmission solutions (i.e., new lines). In addition to addressing specific reliability or congestion problems, transmission upgrades typically provide redundancies that improve system resilience under emergency conditions [51].

**Transmission regulations.** Generally, PFCs are installed on or in line with existing transmission infrastructure. Without the consent or participation of transmission owners, it will be difficult for third parties to install PFC systems [52]. This dynamic could impede the ability of new market participants to propose PFC solutions in a competitive transmission solicitation. Additionally, existing provisions in FERC policies might discourage deployment of these technologies. For example, the reforms in FERC Order 1000 do not affect the right of an incumbent transmission provider to build, own, and recover costs for upgrades to the transmission provider's own facilities. This means that a transmission owner could maintain a Federal right of first refusal for PFC upgrades [53]. Alternatively, PFC solutions proposed by the incumbent could be perceived by non-incumbents as deliberate attempts to maintain right of first refusal and avoid larger projects that would be open to competitive procurement [53].

## Power Flow Controllers: Direct Current Technologies

Unlike AC PFC technologies, which modify parameters that govern network power flows, DC technologies operate outside the constraints of synchronous AC systems, thus providing greater flexibility, power flow control, and efficiency in some cases. While more limited in deployments than AC transmission technologies due to cost and complexity, DC PFC technologies are used in strategic application. High-Voltage Direct Current (HVDC) systems are typically used to transfer large amounts of power over long distances, from one point to another. These types of systems can also be used to transfer power between asynchronous AC networks, something that is not possible with AC PFC technologies.<sup>k</sup>

Generally, an HVDC link consists of two converters (AC-to-DC on one end and DC-to-AC on the other), HVDC transmission lines, and associated substations. Until the 1990s, HVDC converters were primarily constructed with thyristor valves [54]. In the mid-1990s, converters using newer power electronic devices (e.g., insulated-gate bipolar transistors) were commercialized for HVDC applications.<sup>l</sup> The newer technology made deploying smaller HVDC links more economical while providing more precise control of real and reactive power flows [55].<sup>m</sup> Advances in HVDC cable technology, including the development of new lightweight polymer-insulated cables, have also helped to reduce installation times and improve the economics of HVDC systems [56].

In the United States, the first commercial HVDC system was the 500-kV Pacific DC Intertie connecting the Bonneville Power Administration's service territory in the Pacific Northwest to the Los Angeles Department of Water and Power (LADWP) service territory in California that was completed in 1970 [57]. In addition to utility-developed HVDC systems, several merchant HVDC links have been developed in the past few years, as shown in [Figure 9](#). There are also numerous back-to-back converters connecting the different North American interconnections to transfer power asynchronously. More recently, several HVDC transmission projects have been proposed to connect low-cost electricity from wind resources in the upper-central Midwest and solar resources in the Southwest to high-priced demand centers on the east and west coasts. Projects include the TransWest Express Transmission Project, the Grain Belt Express transmission line, and the SOO Green HVDC Link [58] [59] [60].

---

<sup>k</sup> The U.S. power system comprises three main power grids or interconnections—the Eastern Interconnection, the Western Interconnection and the Texas Interconnection. Although electric utilities in each interconnection operate at a synchronized frequency of 60 Hz, each interconnection operates asynchronously with the others, and HVDC systems are used to tie them together.

<sup>l</sup> These converters use power electronics devices such as insulated-gate bipolar transistors (IGBTs), gate turn-off (GTO) thyristors, and integrated gate-commutated thyristors (IGCTs). The technology is often referred to as voltage-source converters (VSCs).

<sup>m</sup> Real power is the power that is actually used or dissipated in the network. Reactive power is power that is stored in the magnetic fields of inductors and capacitors, which aids in sustaining voltages in the system.

TransWest Express is expected to deliver wind energy produced in Wyoming to the Desert Southwest (California, Nevada, Arizona); the Grain Belt Express proposes to collect wind energy in Kansas and deliver it to Missouri, Illinois, and potentially points east within the PJM service area; and the SOO Green HVDC Link, an underground HVDC line, would connect wind resources in Iowa to demand centers in Illinois, providing access to the PJM market.



**Figure 9. Existing HVDC lines and interties in North America.**

Source: U.S. DOE, *Applications for High-Voltage Direct Current Transmission Technologies* [61] and ICF.

Most HVDC links are two-terminal systems, limiting the ability to control power flows between multiple points in the grid. Due to converter limitations and other technical challenges, it has not been practical to develop multi-terminal HVDC (MTDC) systems in most cases. However, advances in power electronics technology and greater demand for renewable energy have made MTDC networks more attractive in recent years [62]. Extending HVDC links to MTDC systems is challenging but progress is being made. [Table 2](#) shows MTDC systems currently in operation; it is important to note China’s lead in this growing technology area. Additional information on DC PFC technologies can be found in the Appendix.

**Table 2. Selected Multi-Terminal HVDC Projects<sup>n</sup>**

Location	Country	Status	No. of Terminals	Capacity (MW)	Voltage (kV)	In-Service Year
Italy-Corsica-Sardinia (SACOI)	Italy	Active	3	200,50,200	+200	1967,1988,1992
Quebec-New England	Canada, U.S.	Active	3	2250,2138,1800	±450	1990,1992

<sup>n</sup> The Quebec – New England link was designed as a five-terminal MTDC, but the original two-terminal link was not integrated into the three-terminal link.

Location	Country	Status	No. of Terminals	Capacity (MW)	Voltage (kV)	In-Service Year
Nanao	China	Active	3	200,150,50	±160	2013
Zhousan	China	Active	5	400,300,100,100,100	±200	2014
North-East Agra	India	Active	4	6000	±800	2017
Zhangbei	China	Active	4	1500	±500	2019

Source: Rodriguez P., K. Rouzbehi, *Multi-terminal DC Grids: Challenges and Prospects*, July 2017, with adjustments by ICF. [63]

### Opportunities

**Cost-effective power delivery.** Due to HVDC's ability to bypass areas of congestion and directly move power from one point to another, it is often the technology of choice to deliver large amounts of power over long distances when economically viable. Compared with conventional AC transmission lines with similar voltage and capacity, HVDC lines have a smaller ROW requirement, with up to 50 percent reduction in some cases [64]. For example, a bipolar HVDC line requires only two conductors compared with six conductors in a double-circuit AC line for the same transmission capacity, leading to smaller transmission tower configurations. As a result, the construction costs of HVDC lines are lower than those of comparable HVAC lines after a break-even distance (e.g., 300 km for a 1200 MW system) despite the additional converter costs. Additionally, the losses on HVDC lines are roughly 3.5 percent per 1,000 km compared with 6.7 percent for comparable AC lines, improving cost-effectiveness in the long term [64].

**Larger transmission capacity.** HVDC lines operate at rated peak voltage at all times, unlike AC lines that vary across time. Because the average voltage on an AC line is only 71 percent of the rated peak, the power transmission capacity of an HVDC line with the same voltage is approximately 40 percent higher. This fact can be useful in areas with limited ROWs; converting an AC line to HVDC would be a potential solution to increasing transmission capacity. Additionally, HVDC lines can operate at overloads (10 to 15 percent higher than the rated capacity) for a limited period (less than 30 minutes). This increased capacity under contingency conditions gives system operators sufficient time to implement mitigation measures, improving system reliability and resilience.

**Unique capabilities.** HVDC's capabilities often make it the only viable option for challenging and unique applications. For example, in underwater or underground power delivery applications, the physical characteristics of marine and underground cables result in excessive voltage drops that limit the maximum distance possible with AC transmission lines [65]. Additionally, because HVDC systems can operate asynchronously, they can readily connect to any voltage and frequency for use as interties between different AC networks worldwide. This ability also supports new system architectures and operating concepts to be realized, such as networked microgrids and fractal grids (i.e., a grid composed of microgrids connected asynchronously that can change in size and scope dynamically), which are inherently more robust, reliable, and resilient. Newer HVDC technology (i.e., voltage source converters) can control system voltages and frequency precisely, enabling it to help restart the grid following a blackout.

**System buffering.** HVDC links can help buffer different parts of the power system, helping to manage instabilities and prevent cascading failures from propagating. For example, the Quebec system survived the power surges during the 2003 northeast blackout because it is connected to the eastern interconnection by HVDC lines [66]. HVDC lines can actively inject power to balance the grid during supply-demand mismatches, helping to improve grid stability and reliability during disturbances. HVDC systems can also buffer the grid from the intermittency associated with variable renewable resources [67]. Aggregating the output of numerous variable energy resources (e.g., wind farms) with HVDC systems decrease overall supply fluctuations and help increase reliability. The enhanced controllability and ability to inject power at any point on the AC network is a primary reason why large-scale renewable developments increasingly consider HVDC technology in project designs.

### Specific Barriers

**High converter costs.** Due to the high costs of HVDC converter stations and requirements for system protection, short distance HVDC links are generally not economically feasible. Because the cost-per-mile of DC transmission lines is lower than AC lines, HVDC systems only become viable beyond a critical distance (e.g., 37 miles for submarine lines and 124 miles for overhead lines) as displayed in Figure 10, thus limiting their broader application. HVDC system components are also more complex with O&M costs that can be higher than AC technologies. Additionally, HVDC components between vendors are not necessarily interchangeable or interoperable, increasing costs and complexity over the lifetime of a project. To address these challenges and increase the use of DC systems in power system applications, DOE developed a Solid State Power Substation (SSPS) technology roadmap [68].

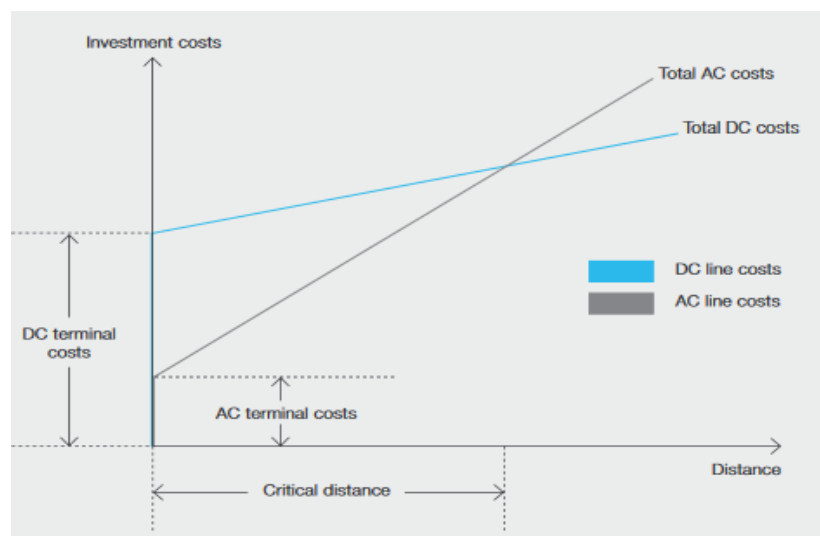

**Figure 10. Cost comparison curves for HVDC and AC lines (generic estimates).**

Source: ABB [65].

**Financing and cost allocation.** Under FERC Order 1000, beneficiaries of a transmission project must pay for the project's cost. With HVDC point-to-point transfers, it can be simple to determine the primary beneficiaries. However, when these lines cross states that do not directly benefit, cost allocation can become quite complex and contentious.

It is difficult to build a project in which costs (e.g., ROWs, environmental impact) are imposed without some allocation of benefits. Another related barrier is that AC transmission projects and non-transmission alternatives might be easier to finance than HVDC technologies [69]. HVDC systems will need to compete with these other solutions that system planners and transmission owners are more familiar with, easier to justify on a cost basis, and have a more secure or faster return [70]. Assessments of HVDC investments should account for the benefits beyond market impacts effects such as enhanced power flow control, which can mitigate difficult loop flows [63].

**Modeling and controls.** The critical component of HVDC systems is the converter. This power electronics technology can have a much faster response time than typical generator controls, which are coupled to the AC system frequency. Faster controls can be advantageous, but it can introduce new dynamics and interactions that have not been studied. More precise models and tools are needed to assess the dynamic response and behavior of the entire system to evaluate control strategies. Despite higher fidelity models being required, the models must be simple enough for practical use in system planning and operation. Understanding stability of MTDC applications will be challenging since these systems have no inherent frequency or inertia, complicating controls and analysis. Accurately capturing the dynamics and interactions within AC networks is needed to design HVDC controllers and identify protection and control strategies to avoid system instability or collapse.

**Protection.** Because DC does not cycle in time, HVDC systems require equipment that can force the current to zero for system protection. Mechanical circuit breakers can be used but are too slow (tens of milliseconds) to minimize arcing and excessive wear [71]. These systems also require additional components to successfully break the current and are challenging to build [72]. Newly developed HVDC breakers based on semiconductors can also be used [70]. These breakers operate faster and address the limitations of mechanical designs but have reliability challenges in the event of frequent short-circuit faults. The hybrid HVDC breaker, which combines mechanical and power electronic components, can overcome these problems.

In addition to HVDC circuit breakers, the main challenge for protecting MTDC systems is their novel operating paradigm with no system frequency or inertia. Effective system protection requires the ability to identify, locate, and isolate faulted lines from the network while keeping the rest of the system in operation. Traditional AC networks use various protection schemes such as distance relaying to identify and locate faults. However, these established approaches cannot be applied to MTDC systems, necessitating research and development of new methods and technologies for fault identification and location [70].

## Advanced Conductors and Cables

Conductors and cables are the fundamental hardware that carry electricity along a transmission line. The most common overhead conductor in use today is the Aluminum Conductor Steel Reinforced (ACSR), and it continues to be one of the most popular types used across the world.



Advances in materials and manufacturing have led to the introduction of many new conductors with better performance; these technologies are generally referred to as “advanced overhead conductors” (AOHCs). The primary characteristics of AOHCs include lower losses, higher current-carrying capacity, lower weight, and low sag at high temperatures—directly addressing the thermal limits of transmission lines.

AOHCs employ advanced aluminum alloys, steel, and composite materials in novel ways that provide enhanced performance over conventional overhead conductors. Some recent types include Aluminum Conductor Composite Reinforced (ACCR); Aluminum Conductor Composite Core (ACCC); and Aluminum Conductor Carbon Fiber Reinforced (ACFR). Worldwide, utilities have used AOHCs in a variety of applications to increase transmission capacity and to bolster a line’s strength and robustness in harsh environments. For example, more than 750 projects across the world have employed ACCC conductors, representing approximately 62,000 miles of transmission lines [73]. Meanwhile, ACCR conductors are found in more than 140 countries across five continents [74]. ACFR conductors are not as widespread as the others and are primarily used in Southeast Asia [75].

Superconducting cables are another type of advanced transmission technology. They are composed of materials that have near-zero resistance at extremely low temperatures, offering little to no electrical losses if used in transmission. However, superconducting technology does require special cooling fluids and cryogenic systems to maintain the low temperatures needed for proper operation. To realize this opportunity, DOE began research and development efforts on high-temperature superconductor (HTS) equipment in 1988 [76]. The world’s first HTS cable was energized in 2000; this was followed by several HTS cable projects in the United States including National Grid’s HTS Cable Project in Albany, New York, and Commonwealth Edison’s Resilient Electric Grid (REG) Project in Chicago, Illinois, sponsored by the Department of Homeland Security [77] [78] [79]. More information on advanced conductors and cables can be found in the Appendix.

### Opportunities

**Increasing transmission capacity.** AOHCs can have a maximum current-carrying capacity of up to two times that of conventional conductors, supporting more power to be transferred through a given transmission corridor. Because securing approvals to build a new transmission line is often very difficult, reconductoring existing transmission lines with AOHCs can double the capacity while using the existing transmission towers and established ROWs. A reconductoring project may cost up to half as much as a new transmission line and can be completed in a significantly shorter amount of time.

Superconducting cables can provide up to ten times the maximum current-carrying capacity of conventional cables with the same cross-sectional area. Underground transmission cables are often used in dense urban areas where there is insufficient space or receptivity for overhead lines. In these areas, there is usually significant competition for limited underground space. HTS cables may be the only viable solution to increase transmission capacity within the available space, especially to meet demand growth from the potential mass adoption of EVs.

**Reduced total costs.** While the cost of AOHCs ranges from 1.5 to 5 times that of conventional conductors, there is potential to reduce total project costs [80]. Because AOHCs have lower weight than ASCR for the same capacity, the transmission towers required could be less robust and less costly. The lower sag of AOHCs also means that the distance between towers could be greater, resulting in fewer towers and lower costs. Additionally, AOHCs exhibit 25–40 percent lower electrical losses compared with conventional conductors [81]. This higher efficiency will result in lower system operating costs. Superconducting cables also exhibit very low losses. While the auxiliary cooling systems required to maintain the low operating temperature consume energy continuously, AOHCs are still more efficient than a traditional conductor at full loading.

**More robust transmission.** During contingencies, overhead transmission lines may be required to deliver greater amounts of power than originally designed for. Higher line loading increases sag, potentially leading to flashovers<sup>o</sup> and line outages that could result in cascading failures and widespread disruption.<sup>p</sup> AOHC's improved strength and robustness leads to lower sag in emergency situations, mitigating these concerns. Additionally, they are better at withstanding stress from high winds, physical loading from snow and ice, heat from wildfires or heatwaves, and other harsh conditions, increasing reliability. Underground transmission cables are rarely damaged during storms, tornados, and hurricanes (but can be susceptible to flooding from storm surge). Superconducting cables would enjoy the same relative immunity from damage during extreme weather events while providing significantly increased transmission capacity, as long as the cooling systems above ground are not impacted by these events.

### Specific Barriers

**High costs.** The U.S. Energy Information Administration projects that electricity demand will grow at an annual average rate of one percent over the period of 2019 to 2050 due to increases in energy efficiency [82]. Because increased transmission capacity is a primary benefit of using advanced conductors and cables, a low electric growth rate may limit the need for new transmission lines or reconductoring projects using AOHCs. In general, building underground transmission is more expensive than overhead lines (up to 10 to 15 times more costly); these higher costs are compounded if HTS cables are used because the technology is still in a pre-commercialization stage [84] [83]. Utilities and the private sector are not willing to invest in or finance these new technologies without the guarantee of tangible benefits.

There remains another design barrier with superconductors that adds to their total cost. Once tripped or de-energized due to loss of the cryogenic cooling system, these superconductors cannot be immediately returned to service if the cooling system was offline for even a short period of time. This is because the conductor needs to cool down to extremely low temperatures (-270 F°) in small increments before re-energizing the line.

---

<sup>o</sup> Transmission line flashover is an electrical discharge between the line and a grounded object, such as a tree.

<sup>p</sup> In 2003, several issues, including transmission outages caused by line sag, led to cascading failures that resulted in shutdowns of much of the U.S. eastern power grid.

So, unlike with traditional AC lines, minor trips cause the superconductor to become unavailable and unreliable for long periods of time, adding extensive costs to maintaining a reliable grid.

**Cryogenic systems.** HTS cables require a reliable supply of coolant at cryogenic temperatures to ensure proper operation. The unavailability of cryogenic systems at a reasonable cost prevents greater adoption of HTS technology [85]. These cooling systems also require constant power, jeopardizing their availability in the event of an outage, negatively affecting broader system reliability and resilience [86]. Advanced cryo-refrigerators have recently been developed that are more efficient and require less maintenance than traditional cryogenic refrigeration systems, addressing some of the needs for HTS cable applications [85]. These new cryogenic systems have been deployed in several HTS projects in South Korea [87] [88].

**Increased complexity.** While AOHCs are relatively simple in concept, their implementation can introduce greater complexity due to new material properties and designs. These factors can affect O&M costs, require new tools and techniques for installation, and additional training, especially for splicing and connecting two spans. Due to the complexity of HTS cable systems, significant technical expertise is needed during the installation and testing process, and for operations and maintenance after energizing the line. The cryogenic systems also add a level of complexity and vulnerability that must be considered in transmission design, planning, and operations.

## V. Integration and Adoption Challenges

Aside from AOHCs, adoption of advanced transmission technologies will challenge the methods in which utilities, system operators, transmission planners, and markets have evolved to-date. Effectively integrating active solutions will require changes to established institutions, regulations, processes, systems, and business practices to reflect the resultant effect. In the case of HTS cables, the cryogenic system is an active component that introduces new vulnerabilities and operating considerations. In addition to the specific barriers identified for each technology, there are fundamental challenges to integration and adoption that are more crosscutting.

**Market readiness.** In regions with ISOs/RTOs, advanced transmission technologies can only influence congestion costs if the technologies are integrated into market and operation systems. A “causality dilemma” exists, however, in which the ISOs/RTOs have no reason to modify systems to accommodate advanced transmission technologies unless sufficient transmission owners choose to adopt them; and transmission owners have no reason to adopt the new technologies unless the ISOs/RTOs systems incorporate such systems into their markets and operations. Market operators also point to technology limitations of existing systems as an impediment to incorporating new technologies into markets and operations. For example, operators using DLR or topology optimization might not have systems immediately capable of handling the larger data volumes or computational complexity associated with these

technologies. Regulators can provide improved guidance and support efforts to recover expenditures needed to integrate new transmission technologies.

FERC has initiated action on these issues through several different initiatives. These efforts encompass a workshop on line rating methodologies (in FERC Docket AD19-15-000), a workshop on advanced transmission technologies (in FERC Docket AD19-19-000), and a notice of proposed rulemaking on transmission incentives (in FERC Docket RM20-10-000), including incentives for advanced transmission technologies. This approach continues to be used.

**Proper evaluation.** Investment decisions in advanced transmission technologies will need to consider total lifecycle costs, including capital costs and O&M costs, weighed against their direct benefits. These evaluations are challenging, and the potential economic benefits identified are specific to individual projects and technologies. Typically, the value of additional transmission capacity provided is compared with the cost of an equivalent amount of incremental generation capacity that would have been needed.

Additionally, advanced transmission technologies must compete against conventional solutions that may be more widely used, better understood, more reliable, less expensive to maintain and repair, and cheaper to install and maintain.

Utilities and grid operators must also be convinced that the benefits of installing advanced transmission technologies outweigh the costs. Other than economics, there are many factors that can influence considerations and trade-offs between technologies, such as vulnerabilities and risks introduced. Advanced transmission technologies can also provide benefits that are more difficult to quantify including the value of asset deferral, improved health monitoring, better situational awareness, improvements in public safety, and increased resilience. Current evaluation methods do not adequately assess technologies across multiple applications and value streams. Consistent frameworks, methods, and supporting modeling and simulations tools are needed to properly evaluate and compare different technologies.

**Insufficient incentives.** Under the current cost-of-service regulatory structure, transmission owners and utilities receive a rate of return on their capital investments for infrastructure projects. Regulators can offer additional incentives to utilities to install advanced transmission technologies. For example, a utility could receive a bonus on its rate of return if it shows that the installation resulted in improvements to several metrics. These metrics could include performance-based outcomes such as reduced outage minutes, number of new customers added, improved efficiency, new renewable capacity connected, greenhouse gas emissions reductions, or other non-energy-related benefits.

The Energy Policy Act of 2005 added section 219 to the Federal Power Act (16 U.S.C. 824s), which directed FERC to develop incentive-based rates for electric transmission. FERC

implemented its incentive policy in a July 2006 order.<sup>9</sup> In a November 2012 policy statement, FERC noted it remained open to new incentive proposals aimed at supporting projects that effectively encourage the deployment of new technologies or of practices that provide demonstrated benefits to consumers [89]. In March 2020, FERC issued a notice of proposed rulemaking for a 100 basis point incentive on the cost of transmission technologies that enhance reliability, efficiency, and capacity, as well as improve the operation of new or existing transmission facilities. This notice also proposed a separate deployment incentive aimed at easing the implementation burden for transmission technologies [90].

Other countries have developed different incentive structures to encourage advanced transmission technologies. For example, the United Kingdom permits a transmission owner to share in the savings if a project costs less than a unit cost target determined by the regulator, incentivizing lower-cost solutions [91] [92]. In Australia, the regulator requires transmission service providers to submit a network capability incentive parameter action plan as part of the revenue request [93] [94]. Transmission owners develop a package of proposals over a five-year planning horizon, and smaller projects receive a 50 percent higher return on capital compared with larger investments.

**Utility risk aversion.** Utilities are generally conservative when it comes to newer technologies because the implications of adopting a solution that ultimately turns out to be problematic can be significant in terms of liability and damage compensation. The conservatism also stems from the fact that a reliable supply of electricity ensures that public health, safety, and essential services can function as needed. Furthermore, the much higher cost to implement and maintain new unproven technologies directly affects customer rates. In the U.S., the electric supply is one of the most reliable in the world, and there is often little incentive to promote and integrate new, unproven technologies in the system. System planners are required to meet transmission planning standards, and new technologies might not perform as well as traditional solutions under normal or high stress events. It is natural for utilities to justify adoption of new technologies due to the severe health, safety, and economic consequences of failures. While this approach is one of the important factors contributing to the current high level of reliability of the power system in the United States, it is also one of the factors contributing to the slower adoption of innovations [95].

Utilities are charged with the responsibility of providing safe and reliable electric service while making prudent, cost-effective investments. As such, it can be difficult to obtain regulatory approval for more expensive and riskier advanced technologies. Regulators need awareness of the broader benefits of advanced transmission technologies, moving away from a focus on minimizing short-term capital costs. Issues of liability could also affect the deployment of these

---

<sup>9</sup> Promoting Transmission Investment through Pricing Reform, Order No. 679, 116 FERC ¶ 61,057, *order on reh'g*, Order No. 679-A, 117 FERC ¶ 61,345 (2006), *order on reh'g*, 119 FERC ¶ 61,062 (2007). On April 2, 2020, FERC published a Notice of Proposed Rulemaking in the Federal Register proposing revisions to the regulations implementing section 219 of the Federal Power Act. 85 Fed. Reg. 18,784 (Apr. 2, 2020). Comments were due July 1, 2020, for FERC's Final Rule.

new technologies. For example, it might not be clear who bears the responsibility if a new technology deployed in the field proves to be faulty over time—the system operator, the transmission owner, or the technology vendor [53]. Utilities should work with vendors and regulators to get aligned on maintenance and service requirements, repair needs, certification, and warranties to manage risks.

**System operator comfort.** Adopting advanced transmission technologies into utility operations will require the integration of technological systems as well as human processes. Some of these technologies might require new equipment in the control room, increase human intervention, and demand additional training. Trust in the performance of the new technologies is also critical for operator comfort. For example, DLRs can deliver inaccurate data at times, which may significantly hamper the operators' ability to dispatch the system while keeping both reliability and economics in mind. Additionally, the higher delivery capacity of HTS cables or HVDC lines means that their loss (due to failures or outages) can result in a greater destabilizing force that can affect grid reliability. This is an important consideration and potential vulnerability that needs to be incorporated into planning and operations.

Utilities and system operators must also be familiar with the operation of these new technologies to mitigate unintended consequences. Utilities must develop plans to train existing staff or hire new personnel to maintain and repair these new technologies after installation.

**Cybersecurity requirements.** Cybersecurity is an important aspect of implementing any grid enhancing system, including advanced transmission technologies. In the recent past, there have been many credible reports that point to cyber intrusion in our energy sector from adversaries abroad. The fact that adversaries have infiltrated the U.S.'s energy systems and can easily cause disruptions to the electric supply highlights the importance of strong cybersecurity. Such actions can result in equipment damage, unintended equipment outages on the bulk-power system, resulting in loss of reliable energy supplies to customers.

Field sensing devices, communication links, third-party hosting services, controllers, power electronics, and other elements of a new system are all potential threat vectors available to malicious actors. To support grid reliability, advanced transmission technologies must comply with NERC reliability standards and other cybersecurity requirements. Ultimately, cybersecurity will depend on product features provided by vendors and a utility's ability to implement these features to develop end-to-end solutions. Cybersecurity is an ongoing process throughout the life cycle of a technology and must be evaluated and updated continuously to be effective. Understanding the implications of cybersecurity requirements and developing best practices for the various advanced transmission technologies will be a challenge. Objective risk assessment methods could provide a means to evaluate risks and prioritize mitigation measures.

**Technology validation.** Utilities and system operators are conservative entities that expect new technology systems and components to be tested, evaluated, and proven to be reliable before adoption. While some large organizations and manufacturers have experience

developing and demonstrating the reliability of new technologies for use in power transmission, there is less experience in the U.S. with long-duration trials and large deployments that require utility partners. This challenge can become insurmountable for advanced transmission technologies developed by smaller or newer companies. Public-private partnerships, with support from academia and research institutions, are needed to validate the performance of new technologies in realistic environments, at scale, and over extended periods. Development of testbeds and research facilities that can prove out these technologies on smaller scales will also help. Finally, tutorials and educational forums to enhance knowledge, share lessons learned, and disseminate validation results are needed to accelerate adoption.

## **VI. Conclusion**

In light of the rapid changes to the U.S. electric power system, from increased penetration of variable renewable generation to more frequent and extreme weather events, new challenges are arising that affect the reliability, efficiency, and effective use of the transmission network. Today's electric grid faces limitations in terms of both software and hardware capabilities to address these challenges, highlighting opportunities to improve situational awareness, flexibility, and resilience. Solution sets that span both software and hardware components are needed to address current and future grid challenges.

From real-time monitoring of transmission lines and software tools that optimize decision making, to new PFCs that provide faster response and improved conductors that increase thermal limits, to ensure addressing Cyber threat issues in a timely manner, a portfolio of technology solutions exists that can be used to enhance the efficiency, effectiveness, reliability, and resilience of the transmission system.

Advanced transmission technologies are diverse in maturity, application, and capabilities. Some solutions have existed since the 1900s, whereas others have only been made possible due to recent advances in underlying technologies such as communications, computation, and power electronics. Some are relatively simple to adopt, while others are more sophisticated, and some can fundamentally change existing grid operating paradigms. These technologies all possess different capabilities that can improve the transmission system, but they also face unique barriers. Selecting the optimal set of technologies for a given situation will require assessments that can evaluate advanced transmission technologies against one another, as well as against traditional solutions. While direct economic benefits can be apparent, other benefits are harder to quantify, such as improved situational awareness, asset deferral, and improved resilience. A robust framework and methodology, along with associated modeling and simulation tools, are needed to support this determination.

Despite the potential benefits offered by these advanced transmission technologies, several broad issues can impede their integration and adoption. Market readiness, market design issues, insufficient incentives, misalignment of incentives, utility risk mitigation, operator acceptance, planning limitations, incumbency issues, third party operation of equipment, and mitigation of cybersecurity concerns are all challenges that require both technical and

nontechnical solutions and new approaches by utilities, grid operators, and regulators. In most cases, cost reductions and proven field performance are requirements for broader deployment. DOE, working in concert with the private sector and research institutions, can support education, research, development, and demonstration efforts to address these barriers and concerns. Success in these endeavors can accelerate commercialization of products that will see growing markets worldwide. Investing in advanced transmission technologies presents opportunities for U.S. leadership and domestic manufacturing, especially with grid hardware technologies.



## VII. Appendix

### Dynamic Line Rating

Dynamic line rating (DLR) technologies are systems and methods that can be used to determine the real-time or forecasted current-carrying capacity (or ampacity) of transmission lines. This dynamic rating is achieved through calculations based on measurements of ambient conditions and the physical properties of the line, while ensuring reliability standards specified by the North American Electric Reliability Corporation (NERC) are met.

DLR systems provide the ability for operators to adjust line ratings ahead of time or in real-time conditions to help relieve transmission challenges. Static line ratings (SLRs) are calculated using conservative assumptions about system conditions and are kept fixed over long periods of time. Dynamic ratings are often higher than these static ratings, unlocking available capacity that would otherwise have been unused. DLRs can also provide flexibility that can help system operators improve operational efficiency. Ambient adjusted ratings (AARs) can be considered a form of DLR, utilizing changes in ambient air temperatures over time. However, the more advanced DLR methods that use sensors near or on critical line sections provide for enhanced spatial and temporal resolution.

In a typical DLR system, the information acquired by field sensors is transmitted to the control room through communication systems such as satellite radio, cellular networks, fiber optics, or other radio technologies. These communication systems are required to meet NERC's Critical Infrastructure Protection standards to verify data authenticity and to prevent cybersecurity breaches. An analytics engine in the control center validates and filters the sensor information, performs error detection, and calculates the real-time line ratings. The error detection system can flag persistent errors and anomalies that could indicate degrading or malfunctioning sensors, helping to eliminate erroneous calculations. The analytics engine can also be configured to use static ratings as a backup during errors to improve reliability. Weather forecasts have also been combined with analytics engines to forecast line ratings and augment real-time analyses.

#### Line Rating Methods

**Static line rating (SLR)** makes conservative assumptions about environmental conditions to calculate a line limit. A SLR can remain unchanged for the lifetime of the line (decades) unless engineers revisit the assumptions used to calculate the original limit. Static ratings that are adjusted on a seasonal basis may be referred to as seasonal line ratings.

**Ambient adjusted rating (AAR)** uses ambient air temperature to adjust line ratings over time. AAR is considered a form of dynamic rating technology by some stakeholders, although using wide area weather forecasts does not provide the spatial and temporal resolution possible with more advanced dynamic rating methods that use sensors near or on line sections.

**Dynamic line rating (DLR)** uses sensors near or on the line to frequently measure environmental and conductor conditions relevant to line ratings. Environmental conditions affecting line ratings include ambient air temperature, wind speed and direction, solar irradiance, and humidity.

Ultimately, the calculated line rating is transmitted to operator systems (e.g., energy management system [EMS]/SCADA) for use in generation scheduling, dispatch decisions, and other power market functions. The information can also be displayed for network monitoring and control purposes.

Table 3 summarizes recent DLR studies and pilots in the United States, Canada, and Europe. Of the nine projects listed, only three are actual market implementations, and two of these three are outside the United States. The remaining six projects were demonstrations that included the installation of field devices (i.e., sensors), communication networks, and systems for data acquisition and analysis.

*Table 3. Selected DLR Implementation and Pilots in the United States, Canada, and Europe*

Project Participants	Type of Implementation	DLR Benefit(s) Assessed	Benefit Calculation Technique	Observed Financial Benefits (\$)	Increase in Line Capacity
LineVision, PJM, American Electric Power (AEP) [96]	Demonstration	Avoided congestion costs on 18-mile, 500-kV line	Production cost modeling in PROMOD	Annual congestion savings of \$4 M on base case congestion costs of \$78 M (savings were five percent of original congestion costs)	Not mentioned
Oncor, Nexans, Electric Reliability Council of Texas [97]	Demonstration	Increased line capacity, congestion mitigation, and transmission upgrade deferral on several 345-kV and 138-kV lines	Production cost modeling, cost comparison of traditional and DLR solutions	Not mentioned	Six percent–14 percent over ambient-adjusted ratings for 83 percent of the time  30 percent–70 percent over static line ratings for 83 percent of the time
Southwest Power Pool, AEP, Line Vision [98]	Demonstration	Avoided congestion costs on a 2.1-mile, 161-kV line	Calculation of change in real-time market costs	Cost savings of \$18,000 in the real-time market over 300 minutes of congestion	Not mentioned
Genscape, Inc. [99]	Demonstration	Avoided congestion cost on 161-kV line	Calculation based on shift factors and marginal congestion costs	Net annual cost reduction to nearby wind farm of \$655,000 with congestion alleviation	10 percent over static line rating during 90 percent of all hours and 97 percent of hours posting congestion

Project Participants	Type of Implementation	DLR Benefit(s) Assessed	Benefit Calculation Technique	Observed Financial Benefits (\$)	Increase in Line Capacity
New York Power Authority, Electric Power Research Institute [100]	Demonstration	DLR reliability and economics compared with AAR, wind energy integration on two 230-kV lines, 6.5 miles and 37 miles long, respectively	Not mentioned	Not mentioned	24 percent over the static rating for 50 percent of the time and 64 percent over the static rating five percent of the time
PacifiCorp (Wyoming) [101]	Full deployment	Increased line capacity, wind energy integration on 31-mile, 230-kV line	Not mentioned	Not mentioned	19 percent over static line rating. Operation of the DLR system is limited to the winter months
Ampacimon, Elia (Belgium) [102]	Full deployment	Avoided congestion cost on five transmission lines	Production cost modeling	Reduced congestion worth €247,250 (\$266,672) for a 4-hour period	Forecasted DLRs were 10 percent greater on average than the static line ratings
Northern Ireland Electricity [103]	Full deployment	Increased line capacity, wind energy integration on two 110-kV circuits	Not mentioned	Not mentioned	Average increase of 18 percent over static line rating
AltaLink (Canada) [104]	Demonstration	Use of additional headroom on four transmission lines	Not mentioned	Not mentioned	Real-time ratings were above seasonal ratings 95.1 percent of the time, with a mean increase of 72 percent over static ratings

## Topology Optimization

The first production-grade topology optimization software was developed by NewGrid as part of an Advanced Research Projects Agency-Energy (ARPA-E) project that concluded in May 2016 [105]. This project succeeded in developing control algorithms for optimizing transmission network topology that led to commercialization of the *NewGrid Router* software. The tool was first demonstrated in a case study using historical data from the PJM real-time energy markets. The study evaluated three representative weeks in 2010, including one summer, one winter, and one shoulder (autumn) week. Using generation and transmission constraint data together with a fully detailed nodal model of the network, the software was able to identify reconfiguration actions that resulted in a 50 percent reduction in real-time PJM congestion costs. This result extrapolates to an estimated annual production cost savings of over \$100 million across PJM [106].

In 2018, the Brattle Group and NewGrid studied the benefits of topology optimization for the Southwest Power Pool (SPP) market. In this study, SPP staff selected 20 real-time snapshots of the SPP system as a representative set of complex constraints under severe or extreme system conditions. The *NewGrid Router* software identified reconfiguration options for the selected constraints, which were then validated on the EMS to ensure the solutions were feasible and met pre- and post-contingency reliability criteria. Figure 11 illustrates the architecture for the software, which iterates between exploring possible reconfiguration solutions and analysis to verify it is feasible and does not result in new violations.

The solutions identified suggest that the real-time market cost savings were three percent of congestion costs, on average. Using historical real-time congestion, the study estimated that the software could provide annual real-time market savings of \$18–\$44 million when used with market optimization [32].<sup>†</sup>

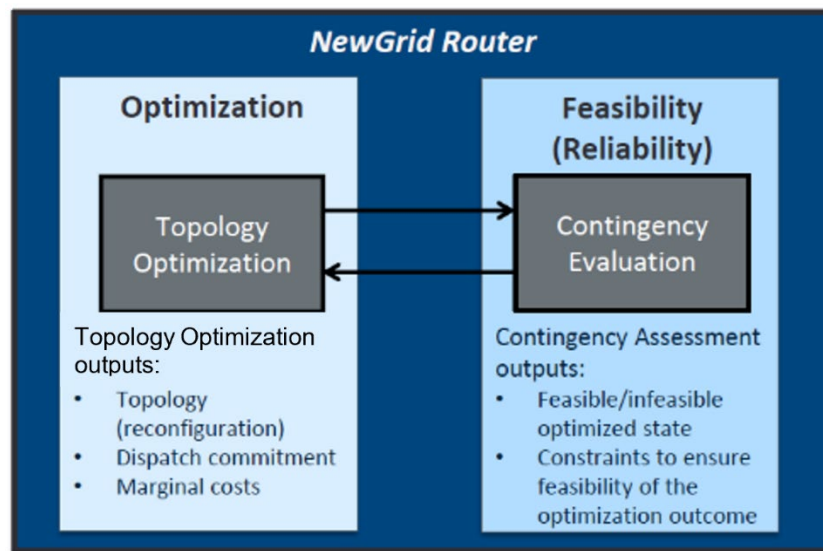

Figure 11. NewGrid router architecture.

Source: Adapted from "Transmission Topology Optimization: A Software Solution for Improving Congestion Management" (slide 5); <https://www.esig.energy/event/webinar-transmission-topology-optimization-a-software-solution-for-improving-congestion-management> [30]

SPP subsequently implemented a pilot that used the topology optimization software to identify reconfiguration solutions to previously observed transmission overloads [32]. Several solutions were used to develop new operating guides for operators.<sup>§</sup> In one instance, the software identified a pre-contingency mitigation plan that reduced the constraint flow by more than 20 percent and eliminated the post-contingency overloads.

<sup>†</sup> Market optimization supports generation to be redispatched following the topology reconfiguration solution to provide additional market savings.

<sup>§</sup> Operating guides contain instructions to execute predefined transmission system actions, such as the previously defined Special Protection Schemes or Remedial Action Schemes, in response to various system conditions to prevent or resolve transmission security violations.

SPP also used the *NewGrid Router* software to investigate switching solutions to mitigate demand curtailments allowed under NERC Transmission System Planning Performance Requirements TPL-001-4.<sup>†</sup> For all three events considered, where SPP's established plans required substantial demand shedding, the software found corrective reconfigurations that relieved the flow violations without load shedding and did not cause any other violations [32].

The Electric Reliability Council of Texas (ERCOT) currently uses topology optimization in operations planning, including development of a Constraint Management Plans (CMP) [107]. CMPs are of a set of predefined transmission system actions to be executed in response to system conditions that would lead to security violations. Using the *NewGrid Router* software, ERCOT was able to avoid load shedding actions in a previously defined CMP by identifying an alternative solution [108]. Meanwhile, the other existing CMPs were verified as the most effective solutions using the same software.

## Power Flow Controllers: Alternating Current Technologies

Power flow control is the ability to change the way power flows through a transmission line or network. This ability can improve the utilization of the grid, for example, by redirecting power flow from congested lines to lines with available capacity. Power flow controllers (PFCs) operate by adjusting the parameters that determine the amount and direction of flow in a transmission line. As shown in the box, the real and reactive power flowing on a line is governed by four key variables. Technologies that can effectively change any one of these parameters will function as an AC PFC. When considering the effect of these four parameters, active and reactive power flow control can be effectively decoupled. The physics of the system indicate that changes to the voltages have a larger effect on reactive power flow, whereas changes to the impedance (or reactance) and the phase angle have a stronger effect on real power flow.

### Governing Equation for AC Power Flows

To understand how alternating current (AC) power flow control technologies work, consider the four variables that govern the flow on a transmission line shown in the equation below:

$$P + iQ = \frac{V_1 * V_2}{X} \sin \delta + i \left( \frac{V_1^2}{X} - \frac{V_1 * V_2}{X} \cos \delta \right)$$

Where

P is the real power flowing on the line

Q is the reactive power flowing on the line

V<sub>1</sub> is the sending end voltage

V<sub>2</sub> is the receiving end voltage

X is the reactance of the line

δ is the difference in phase angles between the sending and receiving end voltages

<sup>†</sup> NERC Reliability Standard TPL-001-4 establishes transmission system planning performance requirements following a wide range of probable contingencies. Under the most severe contingencies, load shedding is a mitigation method to resolve violations resulting from the contingency.

By similar reasoning, technologies that adjust voltages control reactive power flow, while technologies that adjust impedances and phase angles control real power flow.

The earliest AC PFC technologies were phase-shifting transformers (PST) and tap-changing transformers, which are still in operational use today. PSTs change the voltage angle on one end of a transmission line to control real power flows, while load tap-changing transformers adjust voltages (via taps corresponding to different transformer turn ratios) to control reactive power flows. The main drawback of these technologies is that they are mechanically switched, resulting in slow response and operation in discrete steps. PFC technologies that change impedance include controllable capacitors or reactors installed in series with the transmission line. [Table 4](#) summarizes conventional PFCs and associated control methods.

*Table 4. Conventional PFC Technologies*

Device	Control Method
Phase-Shifting Transformer	Angle Variation
Series Capacitor	Impedance Variation
Switched Shunt Capacitor and Reactor	Voltage Variation
Synchronous Condenser	

Flexible AC transmission system (FACTS) devices are a family of AC PFCs based on solid state devices. The first FACTS devices were static Var compensators (SVCs), thyristor-based units that offered fast, dynamic, shunt compensation by controlling a reactor or shunt capacitor. Later on, the thyristor-controlled series capacitor (TCSC) was introduced, to support greater power transfer capability. Advanced PFC technologies available today, which are based on improved power electronics, are smaller, faster, and do not produce harmonics. Examples include the Static Series Synchronous Compensator (SSSC), the Static Synchronous Compensator (STATCOM), and the Unified Power Flow Controller (UPFC), which combines an SSSC and a STATCOM. [Table 5](#) lists several FACTS devices and their control methods.

*Table 5. FACTS Devices*

Device	Control Method
Thyristor Switched Series Compensator	Impedance Variation
Thyristor-Controlled Series Compensator	
Static Synchronous Series Compensator	
Static Var Compensator	Voltage Variation
Static Compensator	
Unified Power Flow Controller	Other
Interline Power Flow Controller	

ARPA-E’s Green Electricity Network Integration (GENI) program focused on advancing PFCs and other technologies that would help increase flexibility in the grid, investing \$35.5 million across 15 different projects [109]. GENI helped develop new PFC technologies that are simpler, more compact and scalable, and more responsive than traditional PFCs.

These solutions included Smart Wires' modular PFC technology, Oak Ridge National Laboratory's magnetic amplifier, Michigan State University's transformerless UPFC, and Varentec's compact dynamic phase angle regulators (CD-PARs).

Smart Wires' distributed series reactors are small, modular, and thus easily deployable. These devices vary the impedance on the transmission line to reroute power flows. In 2013, the Tennessee Valley Authority successfully tested 100 of these units on a 161-kV transmission line in Knoxville, Tennessee [110]. In 2019, Smart Wires collaborated with UK Power on a project dubbed LoadShare to relieve a congested zone on UK Power's network. The project reportedly freed up 95 MW of additional network capacity and saved customers £8 million compared with traditional upgrades. Additionally, National Grid Electricity Transmission in the U.K. signed an agreement with Smart Wires for the installation of five modular power flow devices across their network. This deployment is expected to increase transmission capability by 1.5 GW. Electric utilities in Greece, France, and Australia have also tested these devices on their systems.

Oak Ridge National Laboratory developed a "cost-effective" magnetic amplifier PFC (MAPFC). This device concept consists of a DC control winding and an AC winding, both wrapped around a magnetic iron core similar to that of a large power transformer. During installation, the AC windings are connected in series with a transmission line. Once energized, the power flowing through the device is controlled by varying the current in the DC winding, thus altering the line impedance. Due to the materials used and the relatively simple design, this technology could provide a low-cost PFC solution.

Michigan State University's transformer less UPFC operates with the same principles as a UPFC. It can adjust voltage phase angle and voltage magnitude, thus controlling both real and reactive power flows. As the name implies, the design does not require the large transformers found in conventional UPFC devices, using power electronics instead. These novel devices are compact and lightweight, modular and scalable, easier to install, and have a faster dynamic response than UPFCs. An initial pilot deployed this technology on a 115-kV line from East Towanda to South Troy, Pennsylvania. In addition to increasing wind power injection, the device was tested for its capability to reduce loop flows. The team is on track to install this technology on the MISO system for further testing.

Varentec's CD-PAR is a low-cost option that injects small voltages into a transmission line to control power flow [111]. A prototype was installed on a 12.47-kV distribution network in Georgia by Southern Company for testing. In addition to power flow control, it successfully demonstrated the ability to interconnect radial feeders, giving customers the opportunity to access multiple power sources to boost reliability. The technology concept is expected to be scalable up to the 115-kV to 160-kV range.

## Power Flow Controllers: Direct Current Technologies

High-voltage direct current (HVDC) and converter technology was pioneered by Sweden's ASEA as early as 1929 [112]. The first commercial HVDC link, developed by ASEA, was constructed in 1954 to carry power between mainland Sweden and the island of Gotland. The line was rated at 100-kV and had the capacity to deliver 20 MW of power. Until the 1990s, HVDC converters were constructed with thyristor valves, which could turn on at will but required external circuits to turn off [112]. In the mid-1990s, HVDC converters using more advanced power electronic devices were commercialized.<sup>u</sup> These devices can turn on and off at will, providing improved control and making smaller HVDC systems more economical [55]. HVDC's precise control of voltage and current enables active control of real and reactive power flows [113].<sup>v</sup>

In the United States, the first commercial HVDC project was the 500-kV Pacific DC Intertie connecting the Bonneville Power Administration in the Pacific Northwest to the Los Angeles Department of Water and Power (LADWP) in California [57]. The project was completed in 1970 and was a collaborative effort between General Electric and ASEA. The line was built to deliver low-cost hydropower from the Bonneville Power Administration region to demand centers in southern California. Another project in the Western Interconnection is the Intermountain HVDC Transmission link (or Path 27) between the Adelanto Converter Station in the LADWP service territory and the Intermountain Converter Station in Delta, Utah. This bipolar line is capable of operating at  $\pm 500$  kV and transmitting up to 2,400 MW of power. In the Eastern Interconnection, the longest-operating HVDC link is the Quebec-New England Transmission that connects Radisson, Quebec and Sandy Point in Ayer, Massachusetts. The line is capable of operating at  $\pm 450$  kV and can transmit up to 2,000 MW. This line was built to deliver low-cost hydropower from the Hydro-Quebec region to demand centers in the Boston area of Massachusetts [114].

Until recently, the longest HVDC line in the world was the Rio Madeira link in Brazil, at 600-kV and 2,400 kilometers (km) long, connecting hydropower plants in the Madeira River in the Amazon basin to major urban demand centers such as São Paulo and Rio de Janeiro in the southeastern part of Brazil [115]. In January 2019, China energized the Changji-Guquan ultra-high-voltage direct current (UHVDC) link between the Xinjiang regions in the northwest to Anhui province in the eastern region of China. The UHVDC line is rated at 1,100-kV, spans 3,000 km in length, and provides 12 GW of transmission capacity. The completion of this project set world records for HVDC lines in terms of voltage, transmission capacity, and line length [116]. Even before the Changji-Guquan UHVDC link, China was a world leader in the construction of HVDC transmission lines, having successfully implemented UHVDC transmission lines rated at 800-kV and above [117].

---

<sup>u</sup> These converters used power electronics devices like insulated-gate bipolar transistors (IGBTs), gate turn-off (GTO) thyristors, and integrated gate-commutated thyristors (IGCTs). The technology was referred to as voltage-source converters (VSCs).

<sup>v</sup> Real power is the power that is actually used or dissipated in the network. Reactive power is power that is stored in the magnetic fields of inductors and capacitors, which helps sustain voltages in the system.



In addition to these utility-developed HVDC links, numerous merchant HVDC links have been developed in the past few years. These projects are primarily submarine cable systems that interconnect adjacent ISO/RTO systems or supply power to large urban demand centers. These include Trans Bay Cable in San Francisco ( $\pm 200$  kV, 400 MW), Cross Sound Cable ( $\pm 150$  kV, 330 MW), Neptune Cable (550-kV, 660 MW), and Hudson Transmission Partners (660 MW). In addition, there are more than 15 back-to-back HVDC facilities or AC-AC interties between the grid networks in North America, including the Eastern Interconnect, Western Interconnect, ERCOT, and Comisión Federal de Electricidad (CFE) in Mexico.

Most HVDC links in the United States and elsewhere are in a bipolar configuration [118]. The advantage of a bipolar link is that if one pole or line fails, the link becomes a monopolar link, and half of the rated capacity can still be delivered. For underground or undersea applications, HVDC cables typically come in two types, solid or oil filled [118]. The solid type, also called mass impregnated (MI) cables, are insulated with paper tapes impregnated with high-viscosity oil. MI cables are typically used for long distance, high-voltage applications because they have no length limitations and are more economical. The oil-filled type is completely insulated with low-viscosity oil, works under pressure, and is typically used at distances less than 60 km [118]. In recent years, extruded insulation cables using cross-linked polyethylene (XLPE) have been developed to mitigate concerns with oil leakages [119].

Figure 12 is a schematic comparing HVDC lines to a multi-terminal HVDC (MTDC) network; the dashed lines represent HVDC lines and the solid lines represent AC lines. In both configurations, the HVDC lines connect to the AC network at the same three buses. Although the connections are the same, the MTDC network (right) requires far fewer converters, highlighting one of its major advantages. Despite reduced converters, high costs and technical challenges associated with protection have made it impractical to develop MTDC projects in most cases. Nevertheless, advances in power electronics and increasing demand for renewable energy have made MTDC more attractive in recent years. Newer HVDC systems, using voltage source converters, are more appropriate for MTDC applications.

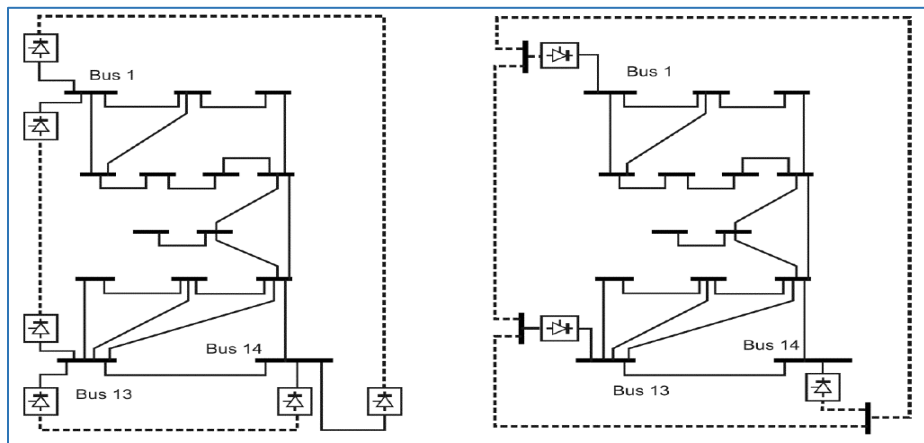

**Figure 12. HVDC lines compared with HVDC network.**

Source: Kirkham, H., et al., *An Introduction to High Voltage DC Networks*, February 2014. [120]

Medium Voltage Direct Current (MVDC) is another DC technology that has become more attractive due to recent changes in the power system and advances in power electronics. Applications such as offshore wind, microgrids with renewable energy sources, data center and buildings, subsea electrification systems, transportation, and oil and gas electrification systems are utilizing MVDC to improve the efficiency and effectiveness of the grid [121]. As shown in Figure 13, MVDC can support the integration of many different types of resources and loads, spanning both AC and DC technologies. This technology can provide efficiencies by reducing the number of conversion stages required to connect renewable generation to the grid, as well as supporting the integration of electric vehicles and sensitive loads on the customer side [122]. While these applications are primarily at or below 69-kV, improved power flow control on the distribution system translates to improvements on the transmission network.

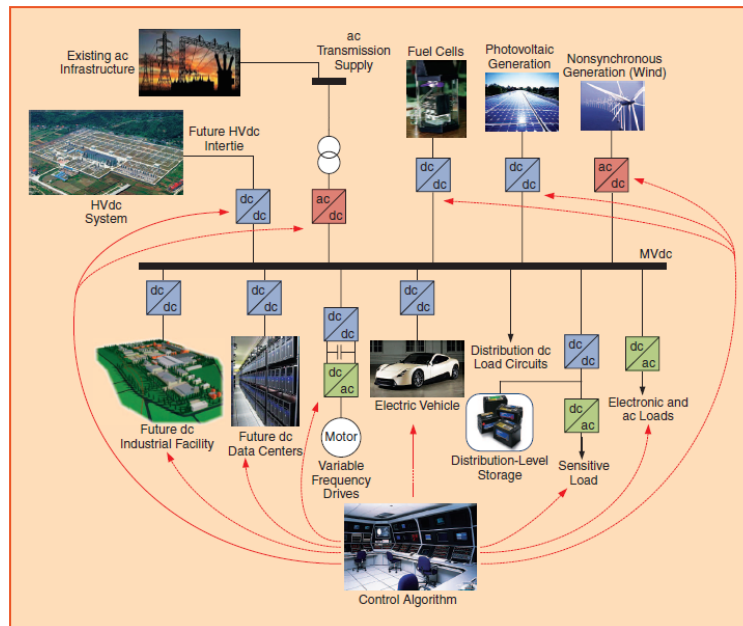

**Figure 13. Conceptual MVDC system.**

Source: Reed, G.F., *Ship to Grid: Medium-Voltage DC Concepts in Theory and Practice*, November 2012. [122]

## Advanced Conductors and Cables

New conductors offering enhanced performance, such as extended high-temperature operation without loss of tensile strength; reduced mechanical, chemical, and electrical deterioration; less elongation; and improved current-carrying capacity, emerged in the middle of the 20th century. These advanced designs include Aluminum Conductor Steel Supported (ACSS), All Aluminum Alloy Conductor (AAAC), Aluminum Conductor Alloy Reinforced (ACAR), and Thermal-Resistant Aluminum Alloy Conductor Steel Reinforced (TACSR) types.

Along with the development of the Gap-type aluminum alloy conductor<sup>w</sup> and Invar alloy conductor,<sup>x</sup> utilities can now deploy transmission lines with a much higher current-carrying capacity because they can operate at higher temperatures for an extended period with low sag. These advanced conductor technologies are also referred to as high-temperature, low-sag (HTLS) conductors.

Manufacturers generally employ two strategies to achieve HTLS conductors. One strategy is to substitute the steel core of traditional Aluminum Conductor Steel Reinforced (ACSR) type conductors with composite materials. These new materials are stronger than steel, stable at high temperatures, and exhibit little sag. Because the composites used do not conduct electricity, the design uses a soft aluminum alloy, compacted together to compensate for the current-carrying properties lost. This strategy is used for the Aluminum Conductor Composite Reinforced (ACCR), Aluminum Conductor Composite Core (ACCC), and Aluminum Conductor Carbon Fiber Reinforced (ACFR) type conductors. The second strategy is to continue to use aluminum and steel alloys, but in novel ways. The designs still use steel alloys to bear most of the tension in the line, but the alloys used can withstand higher temperatures and exhibit lower sag. Additionally, a gap is incorporated between the aluminum strands and the steel core to prevent the aluminum from bearing any tensile force. This configuration uses softer, compacted aluminum for more current-carrying capacity. This strategy is used with the Invar and Gap type conductors. [Table 6](#) discusses these major advanced overhead conductor types, and [Table 7](#) provides examples of actual deployments.

*Table 6. Types of Advanced Overhead Conductors*

Conductor Type	Description
ACCR	The Aluminum Conductor Composite Reinforced type consists of an aluminum matrix composite core reinforced with fiber. The outer layers are made of round aluminum-zirconium wires [123]. The core has lower thermal expansion and better strength than galvanized steel. As a result, the conductor can operate at higher temperatures and ampacities with low sag. The round outer wire also offers large capacity increases [124]. This conductor is meant to be a replacement for ACSR and ACSS conductors.
ACCC	The Aluminum Conductor Composite Core type uses a solid single-piece rod as the core, which acts as the mechanical support for the wire. The core is made of a composite of carbon and glass fiber and is surrounded by glass fibers. Trapezoidal strands of annealed aluminum surround the core [123]. The increased cross-sectional area of the aluminum strands increases the conductor's current-carrying capacity. The core material has a high strength-to-weight ratio. The core's low coefficient of thermal expansion helps reduce sag [125].
ACFR	The Aluminum Conductor Carbon Fiber Reinforced type consists of a stranded carbon fiber core surrounded by aluminum wire, aluminum-zirconium alloy, or annealed aluminum wire. The carbon fiber core offers negligible creep, lower thermal expansion, and a high strength-to-weight ratio. Aluminum wires around the core are arranged in a trapezoidal shape to increase current-carrying capacity [75].

<sup>w</sup> G(Z)TACSR – Gap-type super thermal-resistant aluminum alloy conductor steel reinforced is a common Gap-type conductor. The conductor is built with high heat-resistant aluminum zirconium alloy and an extremely high-strength galvanized steel core.

<sup>x</sup> ZTACIR – The Zirconium alloy aluminum conductor Invar steel reinforced conductor is a common type of Invar conductor. This conductor is similar to ACSR, with a high-strength Invar alloy wire core instead of steel wire.

Conductor Type	Description
Invar	The Invar conductor consists of a galvanized steel core surrounded by heat-resistant grease, in turn surrounded by two layers of aluminum strands. A small gap exists between the innermost aluminum layer and the steel core. This design allows the steel core to bear the entire tensile load of the conductor, especially at high temperatures [123].
Gap	The Gap-type conductor consists of a steel core surrounded by trapezoidal aluminum strands. The uniqueness of this conductor lies in the fact that there exists a small gap between the steel core and innermost aluminum layer. Hence, the core can move independently from the rest of the conductor. Filling heat-resistant grease between the core and the aluminum reduces friction and water penetration. At high temperatures, the conductor is tensioned on the steel core only. The trapezoidal cross sectioning of the aluminum strands increases the current-carrying capacity [123].

*Table 7. Example Advanced Overhead Conductor Projects*

Conductor Type	Vendor/ Participants	Project Location	Project Type	Notes
ACCR [124]	3M	Fargo, North Dakota	Actual deployment	The Western Area Power Administration (WAPA) used an ACCR conductor on a 1-mile, 230-kV line. The line is frequently exposed to high winds, extreme cold, ice loading, and conductor vibrations.
ACCR [124]	3M	Bullhead City, Arizona	Actual deployment	WAPA installed an ACCR conductor on a 20-mile, 230-kV stretch of the Topock-Davis line. The new line helped accommodate demand growth in CA, NV, and AZ.
ACCC [73]	CTC Global	Holland, Michigan	Actual deployment	Conductor installed on a 138-kV, 12-mile line.
ACCC [73]	CTC Global	Waukegan, Illinois	Actual deployment	Conductor installed on a 138-kV, 8-mile line.
ACFR [75]	Tokyo Rope	Guangdong, China	Actual deployment	110-kV conductor deployment.
ACFR [75]	Tokyo Rope	Belo Horizonte, Brazil	Actual deployment	138-kV conductor deployment.

Superconducting cables have the potential to carry large amounts of electricity with little to no losses. In 1967, U.S. scientists published a research paper investigating the deployment of a Niobium Tin (Nb<sub>3</sub>Sn) direct current (DC) superconducting power line cooled to a temperature of 4 kelvins. The design envisioned a power capacity of 100 GW, transmitted over a distance of 1,000 km at a projected cost of \$806 M [126]. Superconducting materials are differentiated mainly on the basis of critical temperature operations.<sup>y</sup> Because superconductivity emerges at extremely low temperatures, scientists have focused research on developing compounds that super conduct at relatively higher temperatures, for more practical applications.

<sup>y</sup> The critical temperature is the temperature at which materials transition into a superconducting state, offering no resistance to the passage of electrical current.

The first high-temperature superconductor (HTS), a lanthanum barium copper oxide compound, was discovered in 1986.<sup>2</sup> Examples of superconducting materials are shown in [Table 8](#).

*Table 8. Superconducting Materials and Critical Temperatures [127]*

Material	Critical Temperature
Niobium Titanium alloy (NbTi)	10 K
Niobium Tin (Nb <sub>3</sub> Sn)	18 K
Yttrium Barium Copper Oxygen (YBCO)	92 K
Bismuth Strontium Calcium Copper Oxygen (BSCCO)	110 K
Magnesium Boride (MgB <sub>2</sub> )	39 K

DOE’s HTS program helped to accelerate the development of this technology, fostering public-private partnerships with researchers, manufacturers, and utilities to realize power system applications [76]. Current state-of-the-art technologies use two types of HTS wire: Bismuth–Strontium–Calcium–Copper–Oxygen (BSCCO), also known as first-generation (1G) wire, and Rare earth–Barium–Copper Oxide (ReBCO), also known as second-generation (2G) wire. Most research efforts are focused on 2G wire because it exhibits better electrical performance, is stronger, and requires a less costly and complex cooling system.

Despite these advancements, there have been limited commercial HTS cable deployments. Utility acceptance of HTS technology would be contingent on multiple demonstration projects lasting at least ten years [76]. Such projects are expensive, and continued financial support is vital for success. In 2016, EPRI observed that “no HTS cable project without government support has yet happened” [83]. Meanwhile, state and National governments in Japan, Korea, China, Germany, and Russia have continued devoting resources to advance HTS research [128]. [Table 9](#) provides examples of actual HTS cable deployments worldwide.

*Table 9. Example HTS Cable Projects [129]*

Conductor Type	Vendor	Project Location	Project Type	Notes
High-Temperature Superconductor (HTS)	Nexans	Long Island, New York	Actual deployment	600-meter line operated by Long Island Power Authority at 138-kV with a rated capacity of 574 MVA.
HTS	South Korean Government	Jeju Island, Korea	Actual deployment	1-kilometer, 154-kV AC line with a rated capacity of 600 MVA and a 500-meter, 80-kV DC cable.
HTS	Southwire	Columbus, Ohio	Cable system was deployed from 2006–2012	200-meter, 13.2-kV, 69 MVA cable was installed as a link between the secondary of a 138-kV, 13.2-kV step-down transformer and 13.2-kV substation bus for American Electric Power.

<sup>2</sup> Early discoveries of superconductivity involved cooling materials to extremely low temperatures (of the order of tens of Kelvin, or –441°F). Scientists have made incremental breakthroughs in developing materials that attain superconductivity at higher temperatures (which are still well below 32°F). Hence, these new superconductors are named high-temperature superconductors.

Conductor Type	Vendor	Project Location	Project Type	Notes
HTS	Korea Electric Power Co., LS Cable Co.	Yongin, South Korea	Actual deployment	1-kilometer, 23-kV cable connecting Heungdeok and Singal substations.
HTS	Nexans	Essen, Germany	Actual deployment	The project was aimed at replacing aging 110-kV, 10-kV T-D infrastructure with 10-kV HTS cables. The rated power and current of the cable are 40 MVA and 2.3 kA, respectively.

## VIII. Bibliography

- [1] Constable, G., et al, *A Century of Innovation: Twenty Engineering Achievements That Transformed Our Lives*, Washington, DC: Joseph Henry Press, 2003.
- [2] Harris Williams & Co., "Transmission & distribution infrastructure," 2010. [Online]. Available: [https://www.harriswilliams.com/sites/default/files/industry\\_reports/finalpercent20TD.pdf](https://www.harriswilliams.com/sites/default/files/industry_reports/finalpercent20TD.pdf). [Accessed 15 January 2019].
- [3] U.S. Department of Energy, "Large power transformers and the U.S. electric grid," 2014. [Online]. Available: <https://www.energy.gov/sites/prod/files/2014/04/f15/LPTStudyUpdate-040914.pdf>. [Accessed 15 January 2019].
- [4] U.S. Department of Energy, "QER report, appendix C: Energy transmission, storage, and distribution infrastructure," 2015. [Online]. Available: <https://www.energy.gov/sites/prod/files/2015/07/f24/ElectricityAppendix.pdf>. [Accessed 4 June 2020].
- [5] *Section 215 of the Federal Power Act, 16 U.S.C. § 824o*.
- [6] U.S. Energy Information Administration, "Utilities continue to increase spending on transmission infrastructure," 2018. [Online]. Available: <https://www.eia.gov/todayinenergy/detail.php?id=34892>. [Accessed 3 June 2020].
- [7] J. Pfeifenberger, J. Chang and J. Tsoukalis, "Investment trends and fundamentals in U.S. transmission and electricity infrastructure," The Brattle Group, 2015.
- [8] J. McCall and T. Goodwin, "Dynamic Line Rating as a Means to Enhance Transmission Grid Resilience," in *CIGRE U.S. National Committee 2015 Grid of the Future Symposium*, 2015.
- [9] U.S. Department of Energy, "Transmission constraints and congestion in the Western and Eastern interconnections 2009-2012," 2014.
- [10] I. Penn, "Why Wall Street gets a cut of your power bill," *Los Angeles Times*, 15 December 2017. [Online]. Available: <https://www.latimes.com/projects/la-fi-electricity-capacityinvestments>. [Accessed 3 June 2020].
- [11] U.S. Department of Energy, "Annual U.S. transmission data review," 2018.
- [12] H. Haibo and J. Yan, "Cyber-physical attacks and defences in the smart grid: a survey," *IET Cyber-Physical Systems: Theory & Applications*, vol. 1, no. 1, pp. 13-27, 2016.
- [13] Federal Energy Regulatory Commission, "Grid reliability and resilience pricing," 2018.

- [14] S. Uski-Joutsenvuo and R. Pasonen, "Maximising power line transmission capability by employing dynamic line ratings—technical survey and applicability in Finland. Accessed April 2020. Available online:," [Online]. Available: <http://sgemfinalreport.fi/files/D5.1.55percent20percent20Dynamicpercent20linepercent20rating.pdf>. [Accessed 3 June 2020].
- [15] A. Michiorri et al., "Forecasting for dynamic line rating," [Online]. Available: <https://hal-mines-paristech.archives-ouvertes.fr/hal-01199238/document>. [Accessed 3 June 2020].
- [16] J. McCall, "Next generation dynamic line rating provides strong economic benefits.," [Online]. Available: <https://electricenergyonline.com/energy/magazine/970/article/Next-Generation-Dynamic-Line-Rating-Provides-Strong-Economic-Benefits.htm>. [Accessed 3 June 2020].
- [17] U.S. Department of Energy, "2019 report to Congress on dynamic line rating," June 2019. [Online]. Available: [https://www.energy.gov/sites/prod/files/2019/08/f66/Congressional\\_DLR\\_Report\\_June\\_2019\\_final\\_508\\_0.pdf](https://www.energy.gov/sites/prod/files/2019/08/f66/Congressional_DLR_Report_June_2019_final_508_0.pdf).
- [18] S. Murphy et al., "Simulating the economic impact of a dynamic line rating project in a regional transmission operator (RTO) environment," 2018. [Online]. Available: <https://cdn2.hubspot.net/hubfs/4412998/CIGREpercent20GOTFpercent202018percent20ONGNpercent20-percent20PJMpercent20AEPpercent20LineVisionpercent20-percent20Final.pdf>. [Accessed 3 June 2020].
- [19] B. Mehraban et al., "An analysis on the economic impacts of dynamic line ratings on a congested transmission line in southwest power pool," 2018. [Online]. Available: <https://cdn2.hubspot.net/hubfs/4412998/CIGREpercent20GOTFpercent202018percent200-percent20SPPpercent20AEPpercent20LineVisionpercent20-percent20Final.pdf>. [Accessed 3 June 2020].
- [20] Southwest Power Pool, "SPP state of the market report," 2018. [Online]. Available: <https://www.spp.org/documents/59861/2018percent20annualpercent20statepercent200ofpercent20thepercent20marketpercent20report.pdf>. [Accessed 5 June 2020].
- [21] California Public Utilities Commission, "SED incident investigation report for 2018 Camp Fire with attachments," [Online]. Available: <cdn.cnn.com/cnn/2019/images/12/03/i1906015.appendix.a.sed.camp.fire.investigation.report.redacted.pdf>. [Accessed 3 June 2020].
- [22] S. K. D. DiSavino, "'Bomb cyclone' hits U.S. East Coast energy, power supply," 4 January 2018. [Online]. Available: <https://www.reuters.com/article/us-usa-weather-energy/bomb-cyclone-hits-u-s-east-coast-energy-power-supply-idUSKBN1ET1GS>. [Accessed June 25 2020].
- [23] J. Kemp, "U.S. power grid survived polar vortex, but only just: Kemp," 3 October 2014. [Online]. Available: <https://www.reuters.com/article/us-usa-power-weather-kemp/u-s>



- power-grid-survived-polar-vortex-but-only-just-kemp-idUSKCN0HQ4TB20141003. [Accessed 25 June 2020].
- [24] Federal Energy Regulatory Commission, "Electric power markets," [Online]. Available: <https://www.ferc.gov/market-assessments/mkt-electric/overview.asp>.
- [25] D. Tom Rizey and P. Ohodnicki, "Sensing and measurement technology roadmap: devices including communications and data analytics requirements," GRID Modernization Laboratory Consortium, 2019.
- [26] A.A. Mazi, B.F. Wollenberg, and M.H. Hesse, "Corrective control of power system flows by line and bus-bar switching," *IEEE Transactions on Power Systems*, vol. 1, no. 3, p. 258–265, 1986.
- [27] A.G. Bakirtzis and A.P.S. Meliopoulos, "Incorporation of switching operations in power system corrective control computations," *IEEE Transactions on Power Systems*, vol. 2, no. 3, p. 669–675, 1987.
- [28] V. Vittal and W. Shao, "Corrective switching algorithm for relieving overloads and voltage violations," *IEEE Transactions on Power Systems*, vol. 20, no. 4, p. 1877–1885, 2005.
- [29] PJM, "Energy management system (EMS) model updates and quality assurance (QA)," in *PJM Manual 3A*, 2019, pp. 51-53.
- [30] P. Ruiz and J. Caspary, "Webinar: transmission topology optimization: a software solution for improving congestion management," 2019. [Online]. Available: <https://www.esig.energy/event/webinar-transmission-topology-optimization-a-software-solution-for-improving-congestion-management/>. [Accessed 3 June 2020].
- [31] S. Oren et al., *Optimal transmission switching: when economic efficiency and FTR markets collide*, Toulouse, France: Presented at Economics of Energy Markets Conference, Jan. 28–29, 2010, 2010.
- [32] P.A. Ruiz and J. Caspary, "Webinar: transmission topology optimization: a software solution for improving congestion management," 2019. [Online]. Available: <https://www.esig.energy/event/webinar-transmission-topology-optimization-a-software-solution-for-improving-congestion-management/>. [Accessed 3 June 2020].
- [33] Ruiz et al., "Transmission topology optimization: pilot study to support congestion management and ice buildup mitigation," [Online]. Available: [http://newgridinc.com/wp-content/uploads/2018/11/Topology-Optimization\\_SPP-Technology-Expo\\_20181115\\_FINAL.pdf](http://newgridinc.com/wp-content/uploads/2018/11/Topology-Optimization_SPP-Technology-Expo_20181115_FINAL.pdf). [Accessed 4 June 2020].
- [34] P.A. Ruiz et al., *Topology control algorithms (TCA): simulations in PJM with AC Modeling*, Washington, DC: FERC Tech. Conf. on Increasing Market Efficiency through Improved Software, Docket AD10-12-005, June 2014, 2014.

- [35] P.A. Ruiz et al., "Transmission topology optimization: a software solution for improving congestion management," in *Energy Systems Integration Group webinar, 19 June 2019*, 2019.
- [36] National Grid, "Network innovation allowance 2016/17," 2017.
- [37] Brattle, "Brattle study for National Grid shows topology optimization can help relieve major transmission constraints in Great Britain," 2017.
- [38] E. B. Fisher, R. P. O'Neill, and M. C. Ferris, "Optimal transmission switching," *IEEE Transactions on Power Systems*, vol. 23, no. 3, p. 1346–1355, 2008.
- [39] K. W. Hedman, R. P. O'Neill, E. B. Fisher, and S. S. Oren, "Optimal transmission switching—sensitivity analysis and extensions," *IEEE Transactions Power Systems*, vol. 23, no. 3, p. 1469–1479, 2008.
- [40] X. Li, P. Balasubramanian, M. Sahraei-Ardakani, M. Abdi-Khorsand, K. W. Hedman and R. Podmore, "Real-time contingency analysis with corrective transmission switching," *IEEE Transactions on Power Systems*, vol. 32, no. 4, p. 2604–2617, 2017.
- [41] S. Oren et al., *Optimal transmission switching: when economic efficiency and FTR markets collide*, Toulouse, France: Economics of Energy Markets Conference, 28–29 January 2010, 2010.
- [42] K. W. Hedman, S. S. Oren, and R. P. O'Neill, "Revenue adequacy constrained optimal transmission switching," in *2011 44th Hawaii International Conference on System Sciences, pp. 1-10.*, Kauai, HI, 2011.
- [43] G.Huang, W. Wang, and J. An, "Stability issues of smart grid transmission line switching," in *IFAC Proceedings, vol. 47, Issue 3, 2014, pages 7305–7310*, 2014.
- [44] X. Li, P. Balasubramanian, M. Sahraei-Ardakani, M. Abdi-Khorsand, K. W. Hedman and R. Podmore, "Real-time contingency analysis with corrective transmission switching," *IEEE Transactions on Power Systems*, vol. 32, no. 4, p. 2604–2617, 2017.
- [45] PJM, "Joint and Common Market: Michigan-Ontario phase angle regulator (PAR) control study update," [Online]. Available: <https://www.pjm.com/-/media/committees-groups/stakeholder-meetings/pjm-miso-joint-common/20170228/20170228-item-06a-michigan-ontario-pars-control-study-update.ashx>. [Accessed 2020].
- [46] NY Power Authority, "Marcy South Series Compensation Project," [Online]. Available: <https://www.nypa.gov/-/media/nypa/documents/document-library/transmission/msscfacts.pdf>. [Accessed 3 June 2020].
- [47] ARPA-E, "GENI program overview," [Online]. Available: [https://arpa-e.energy.gov/sites/default/files/documents/files/GENI\\_ProgramOverview.pdf](https://arpa-e.energy.gov/sites/default/files/documents/files/GENI_ProgramOverview.pdf). [Accessed 4 June 2020].

- [48] U.S. Department of Energy, "TRAC program vision and framework," [Online]. Available: <https://www.energy.gov/sites/prod/files/2020/06/f75/TRACpercent20Programpercent20Visionpercent20andpercent20Framework.pdf>. [Accessed 25 June 2020].
- [49] Smart Wires, "SmartValve," [Online]. Available: <https://www.smartwires.com/smartvalve/>. [Accessed 3 June 2020].
- [50] A. Del Rosso, *Benefits and value of new power flow controllers*, EPRI, 2018.
- [51] M. Kormos, *Grid-enhancing technologies*, FERC Docket No. AD19-19-000, 2019.
- [52] D.B. Patton, *Efficient incentives for grid-enhancing technologies*, FERC Docket No. AD19-19-000, 2019.
- [53] C. Glazer, *Grid-enhancing technologies*, FERC Docket No. AD19-19-000, 2019.
- [54] W. Long and S. Nilsson, "HVDC transmission: yesterday and today," *IEEE Power and Energy Magazine*, vol. 5, no. 2, pp. 22-31, 2007.
- [55] R. Rudervall, J. P. Charpentier, and R. Sharma, "High Voltage Direct Current (HVDC) transmission systems technology review paper," 2000.
- [56] S. Dodds et al, *HVDC VSC (HVDC Light) transmission – operating experiences*, Presented at CIGRE Technical Exhibition 2010, Paris, France, Aug. 22-27, 2010, 2010.
- [57] Bonneville Power Administration, "Direct current line still hot after 40 years," 2010.
- [58] "TransWest Express," [Online]. Available: <http://www.transwestexpress.net>. [Accessed 25 June 2020].
- [59] G. B. Express, "Grain Belt Express: Moving energy from source to market," [Online]. Available: <https://grainbeltexpress.com>. [Accessed 25 June 2020].
- [60] "SOO Green HVDC Link," [Online]. Available: <https://www.soogreenrr.com/about>. [Accessed 25 June 2020].
- [61] U.S. Department of Energy, "Applications for High-Voltage Direct Current Transmission technologies," 2013.
- [62] A. MacDonald, E., C.T.M. Clack, A. Alexander, A. Dunbar, J. Wilczak, and Y. Xie., "Future cost-competitive electricity systems and their impact on US CO2 emissions – supplementary information," *Nature Climate Change*, 2016.
- [63] P. Rodriguez and K. Rouzbehi, "Multi-terminal DC grids: challenges and prospects," *J. Mod. Power Syst. Clean Energy*, vol. 5, pp. 515-523, 2017.
- [64] Siemens, "HVDC classic – low losses.," 2017. [Online]. Available: <https://www.energy.siemens.com/hq/en/power-transmission/hvdc/hvdc-classic.htm#content=Lowpercent20Losses>. [Accessed August 2017].

- [65] ABB, "Special report: 60 years of HVDC," *ABB Review*, p. 1–72, 2014.
- [66] U.S.-Canada Power System Outage Task Force, "Final report on the August 14, 2003, blackout in the United States and Canada: causes and recommendations," 2004.
- [67] M. Brenna, F. Foiadelli, M. Longo, and D. Zaninelli, "Improvement of wind energy production through HVDC systems," *Energies*, vol. 10, p. 157, 2017.
- [68] U.S. Department of Energy, "Solid state power substation technology roadmap," [Online]. Available: <https://www.energy.gov/sites/prod/files/2020/06/f75/2020percent20Solidpercent20Statepercent20Powerpercent20Substationpercent20Technologypercent20Roadmap.pdf>. [Accessed 25 June 2020].
- [69] U.S. Energy Information Administration, "Assessing HVDC transmission for impacts of non-dispatchable generation," June 2018.
- [70] D.V. Hertem and M. Ghandhari, "Multi-terminal VSC HVDC for the European supergrid: obstacles," *Renewable and Sustainable Energy Reviews*, vol. 14, no. 9, pp. 3156-3163, June 2010.
- [71] Å Ekström, et al., "Design and testing of an HVDC circuit breaker," 1976.
- [72] C.M. Franck, "HVDC circuit breakers: a review identifying future research needs," *IEEE Transactions on Power Delivery*, vol. 26, no. 2, pp. 998-1007, 2011.
- [73] CTC Global, "ACCC conductor installations," [Online]. Available: <https://www.ctcglobal.com/project-map/>.
- [74] A. Russell, "3M ACCR presentation," 2014. [Online]. Available: [https://www.ieee.hr/\\_download/repository/Allan\\_Russell\\_3M\\_ACCR\\_percent28Aluminum\\_Conductor\\_Composite\\_Reinforcedpercent29\\_-\\_Proven\\_Solutions\\_to\\_Increase\\_Capacity.pdf](https://www.ieee.hr/_download/repository/Allan_Russell_3M_ACCR_percent28Aluminum_Conductor_Composite_Reinforcedpercent29_-_Proven_Solutions_to_Increase_Capacity.pdf).
- [75] Tokyo Rope, "HTLS conductor installation records," [Online]. Available: <https://www.google.com/maps/d/viewer?mid=1laorOymzoWPuB40J4rHFACal4MEjd6qZ&ll=44.03076990804561percent2C54.0846184752325&z=3>.
- [76] U.S. DOE, "High temperature superconductivity: a history of success," 2015.
- [77] U.S. Department of Energy, "Plugging America into the future of power: project fact sheet," 2008. [Online]. Available: [https://www.energy.gov/sites/prod/files/oeprod/DocumentsandMedia/Albany\\_\\_03\\_05\\_08.pdf](https://www.energy.gov/sites/prod/files/oeprod/DocumentsandMedia/Albany__03_05_08.pdf). [Accessed 4 June 2020].
- [78] U.S. Department of Homeland Security, "DHS science and technology directorate resilient electric grid (REG)," [Online]. Available:

- <https://www.dhs.gov/sites/default/files/publications/Resilient-Electric-Grid-REG-508-v2.2.pdf>. [Accessed 3 June 2020].
- [79] AMC, "AMSC and ComEd Agree to Install Resilient Electric Grid System in Chicago," [Online]. Available: <https://ir.amsc.com/news-releases/news-release-details/amsc-and-comed-agree-install-resilient-electric-grid-system>. [Accessed 3 June 2020].
- [80] R. Elberg, "Advanced overhead conductors: changing the value equation for utility transmission line upgrade and new build projects," CTC Global, 2018.
- [81] D. Bryant, "ACCC conductor can reduce line losses and why everyone should care," 2017. [Online]. Available: <https://www.ctcglobal.com/blog/accc-conductor-reduces-line-losses-everyone-care/>. [Accessed 4 June 2020].
- [82] U.S. Energy Information Administration, "Annual energy outlook," 2020. [Online]. Available: <https://www.eia.gov/outlooks/aeo/>. [Accessed 3 June 2020].
- [83] Xcel Energy, "Overhead vs. Underground: Information about burying high-voltage transmission lines," 2014. [Online]. Available: [https://www.xcelenergy.com/staticfiles/xcel/Corporate/Corporatepercent20PDFs/OverheadVsUnderground\\_FactSheet.pdf](https://www.xcelenergy.com/staticfiles/xcel/Corporate/Corporatepercent20PDFs/OverheadVsUnderground_FactSheet.pdf). [Accessed 25 June 2020].
- [84] S. Eckroad, "Technical analysis and assessment of resilient technologies for the electric grid: task 2—cost and commercialization assessment and market analysis," Electric Power Research Institute, Palo Alto, CA, 2016.
- [85] A. Al-Taie, L. Graber, and S.V. Pamidi, "Technical challenges and potential solutions for cross-country multi-terminal superconducting DC power cables," *IOP Conference Series: Materials Science and Engineering*, vol. 279, no. 012034, 2017.
- [86] H. Thomas et al., "Superconducting transmission lines – Sustainable electric energy transfer with higher public acceptance?," *Renewable and Sustainable Energy Reviews*, vol. 55, pp. 59-72, 2015.
- [87] H. Hirai et al., "Neon turbo-brayton cycle refrigerator for HTS power machines," *AIP Conference Proceedings*, vol. 1434, no. 1, pp. 1672-1679, 2012.
- [88] H. H. e. al., "Development of a turbine-compressor for 10 kW class neon turbo-Brayton refrigerator," *AIP Conference Proceedings*, vol. 1573, pp. 1236-1241, 2014.
- [89] Federal Energy Regulatory Commission, *Promoting transmission investment through pricing reform*, 2012.
- [90] N. o. P. R. Federal Energy Regulatory Commission, *Electric transmission incentives policy under Section 219 of the Federal Power Act, Docket No. RM20-10-000*, 2020.
- [91] Ofgem, "Network regulation – the “RIIO” model," [Online]. Available: <https://www.ofgem.gov.uk/network-regulation-riio-model>. [Accessed 2 June 2020].

- [92] AEE, "Comments of Advanced Energy Economy, Docket No. PL19-3-000," [Online]. Available: [https://elibrary.ferc.gov/IDMWS/file\\_list.asp?document\\_id=14780619](https://elibrary.ferc.gov/IDMWS/file_list.asp?document_id=14780619). [Accessed 25 June 2020].
- [93] A. E. Regulator, *Final electricity transmission network service providers service target performance incentive scheme, version 4.1*, 2014.
- [94] "WATT Coalition Initial Comments, PL19-3-000," 26 June 2019. [Online]. Available: [https://elibrary.ferc.gov/IDMWS/file\\_list.asp?document\\_id=14780494](https://elibrary.ferc.gov/IDMWS/file_list.asp?document_id=14780494). [Accessed 25 June 2020].
- [95] R. Gramlich, *Bringing the grid to life: white paper on the benefits to customers of transmission management technologies, Working for Advanced Transmission Technologies (WATT) Coalition*, 2018.
- [96] S. Murphy, N. Dumitriu, J. Marmillo, N. Pinney, and B. Mehraban, *Simulating the economic impact of a dynamic line rating project in a regional transmission operator (RTO) environment, Presented at the CIGRE U.S. National Committee 2018 Grid of the Future Symposium, Reston, VA, October 28-31*, 2018.
- [97] J. Johnson et al., "Dynamic line rating, Oncor Electric Delivery Smart Grid Program," *Office of Scientific and Technical Information Technical Reports*, 1 August 2013.
- [98] B. Mehraban et al., *An analysis on the economic impacts of dynamic line ratings on a congested transmission line in Southwest Power Pool*, Presented at the CIGRE U.S. National Committee 2018 Grid of the Future Symposium, Reston, VA, October 28-31, 2018.
- [99] J. Verga, N. Pinney, and J. Marmillo, *Incorporating dynamic line ratings to alleviate transmission congestion, increase wind resource utilization, and improve power market efficiency*, Presented at CIGRE US National Committee 2016 Grid of the Future Symposium, Philadelphia, PA. Oct. 30-Nov. 1, 2016.
- [100] A. Phillips, *Evaluation of instrumentation and dynamic thermal ratings for overhead lines*, Office of Scientific and Technical Information, U.S. Department of Energy, 2013.
- [101] PacifiCorp, "Smart Grid Annual Report," 1 July 2015. [Online]. Available: <https://pscdocs.utah.gov/electric/15docs/1503563/267287RMPSmartGridMonitorAnnRep20157-1-2015.pdf>. [Accessed 3 June 2020].
- [102] F. Skivee et al., "Integration of 2 days-ahead capacity forecast to manage Belgian energy imports," 2016. [Online]. Available: [http://www.ampacimon.com/wp-content/uploads/2016/09/Cigre\\_C2\\_PS1\\_\\_20161.pdf](http://www.ampacimon.com/wp-content/uploads/2016/09/Cigre_C2_PS1__20161.pdf).
- [103] Northern Ireland Electricity PLC, *Application paper for the approval of additional capex in RP4, 23*, 2011.

- [104] B. Bhattarai et al., *Transmission line ampacity improvements of AltaLink Wind Plant Overhead tie-lines using weather-based dynamic line rating*, *IEEE PES General Meeting, Idaho National Laboratory, July 2017*.
- [105] ARPA-E, "Decision-support software for grid operators," [Online]. Available: <https://arpa-e.energy.gov/?q=slick-sheet-project/decision-support-software-grid-operators>. [Accessed 1 April 2020].
- [106] P. Ruiz, *Transmission topology optimization: simulation of impacts in PJM day-ahead markets*, Washington, DC: Presented at FERC Tech. Conf. on Increasing Market Efficiency through Improved Software, Docket AD10-12-005, 2014.
- [107] T. B. Tsuchida and R. Gramlich, "Improving transmission operation with advanced technologies: a review of deployment experience and analysis of incentives," The Brattle Group, 2019, p. 19.
- [108] P.A. Ruiz, *Transmission topology optimization: operations and market applications and case studies*, Presented at ERCOT Demand Side Working Group Meeting, Austin, TX, Dec. 6, 2016.
- [109] ARPA, "Green electric network integration," [Online]. Available: <https://arpa-e.energy.gov/?q=programs/geni>. [Accessed 3 June 2020].
- [110] ARPA, "Smart Wires (GENI), developing technology to improve electricity transmission capacity," [Online]. Available: <https://arpa-e.energy.gov/?q=impact-sheet/smart-wires-geni>. [Accessed 4 June 2020].
- [111] ARPA, "Grid modernization with power flow controller," [Online]. Available: <https://arpa-e.energy.gov/?q=impact-sheet/varentec-geni>. [Accessed 3 June 2020].
- [112] W. Long and S. Nilsson, "HVDC transmission: yesterday and today," *IEEE Power & Energy Magazine*, vol. 5, no. 2, p. 22–31, 2007.
- [113] L. Weimers, "HVDC light – a new technology for a better environment," *IEEE Power Engineering Review*, vol. 18, no. 8, pp. 19-20, 1998.
- [114] ABB Québec, "New England: The first large scale multiterminal HVDC transmission in the world to be upgraded," 2020. [Online]. Available: <https://new.abb.com/systems/hvdc/references/quebec-new-england>. [Accessed 4 June 2020].
- [115] ABB, "Rio Madeira – The Longest Transmission Link in the World.," "n.d.. [Online]. Available: <http://new.abb.com/systems/hvdc/references/rio-madeira>. [Accessed 3 June 2020].
- [116] ABB, "Changji-Guquan UHVDC link 12,000 megawatts of electricity over 3,000 kilometers at 1.1 million volts, setting new world records on voltage level, transmission capacity and distance," [Online]. Available:

- <https://new.abb.com/systems/hvdc/references/changji-guquan-uhvdc-link>. [Accessed 4 June 2020].
- [117] ABB, "ABB wins orders of over \$300 million for world's first 1100 kV UHVDC power link in China," 2016. [Online]. Available: <https://new.abb.com/news/detail/13922/abb-wins-orders-of-over-300-million-for-worlds-first-1100-kv-uhvdc-power-link-in-china>. [Accessed 4 June 2020].
- [118] R. Anshika, *3 Main Types of HVDC Links | Transmission | Electrical Engineering*.
- [119] Y. Murata et al., "Development of High Voltage DC-XLPE Cable System," 2013. [Online]. Available: <https://global-sei.com/technology/tr/bn76/pdf/76-09.pdf>. [Accessed 4 June 2020].
- [120] H. Kirkham et. al., "An introduction to high voltage DC networks," U.S. Department of Energy, PNNL-23273, 2014.
- [121] A. Giannakis and D. Peftitsis, "MVDC distribution grids and potential applications: future trends and protection challenges," 2018.
- [122] G.F. Reed, B. Grainger, A. Sparacino, E. Taylor, and Z. Mao, "Ship to grid: medium-voltage DC concepts in theory and practice," *IEEE Power and Energy Magazine*, vol. 10, no. 6, pp. 70-79, 2012.
- [123] EPRI, *Demonstration of advanced conductors for overhead transmission lines, CEC-500-2013-030*, Palo Alto, 2008.
- [124] 3M, "3M aluminum conductor composite reinforced (ACCR) high-capacity transmission conductor," [Online]. Available: <https://multimedia.3m.com/mws/media/4782700/3mtm-accr-technical-summary-english-units.pdf>. [Accessed 4 June 2020].
- [125] CTC Global, "ACCC Conductor," [Online]. Available: <https://www.ctcglobal.com/acc-conductor>.
- [126] R. L. Garwin and J. Matisoo, "Superconducting lines for the transmission of large amounts of electrical power over great distances," in *Proceedings of the IEEE*, vol. 55, no. 4, pp. 538-548, April 1967, 1967.
- [127] EPRI, "Summary report: technical analysis and assessment of resilient technologies for the electric grid: high-temperature superconductivity," Palo Alto, 2017.
- [128] EPRI, "Strategic intelligence update: superconductivity for power delivery applications," Palo Alto, 2015.
- [129] EPRI, "Superconducting power equipment: technology watch," Palo Alto, 2012.
- [130] FERC, "Response of the New York Independent System Operator, Inc," 2018.



- [131] S. U.-J. & R. Pasonen, "Sanna Uski-Joutsenvuo & Riku Pasonen, Maximising power line transmission capability by employing dynamic line ratings—technical survey and applicability in Finland. Accessed April 2020. Available online:," [Online]. Available: <https://www.vttresearch.com/sites/default/files/jul>.
- [132] U. DOE, "Dynamic Line Rating. Report to Congress, June 2019. Available online:," [https://www.energy.gov/sites/prod/files/2019/08/f66/Congressional\\_DLR\\_Report\\_June\\_2019\\_final\\_508\\_0.pdf](https://www.energy.gov/sites/prod/files/2019/08/f66/Congressional_DLR_Report_June_2019_final_508_0.pdf) .
- [133] Southwest Power Pool , "SPP State of the Market Report, 2018. Available online:," [Online]. Available: <https://www.spp.org/documents/59861/2018percent20annualpercent20statepercent20ofpercent20thepercent20marketpercent20report.pdf..>
- [134] P.A. Ruiz, et al., "Transmission topology optimization: a software solution for improving congestion management," presented at Energy Systems Integration Group webinar," in *Presented at Energy Systems Integration Group webinar, 19 June 2019.*, 2019.
- [135] Tokyo Rope, "HTLS Conductor Installation Records August 26-27, 2015".
- [136] P.A. Ruiz et al., "Transmission topology optimization: a software solution for improving congestion management," in *Presented at Energy Systems Integration Group webinar, 2019.*
- [137] J. F. Hauer et al., "Appendix F: Advanced transmission technologies," *National Grid Study, Issue Papers*, May 2002.