

Proposed Southern Connector Trail – Topo Map

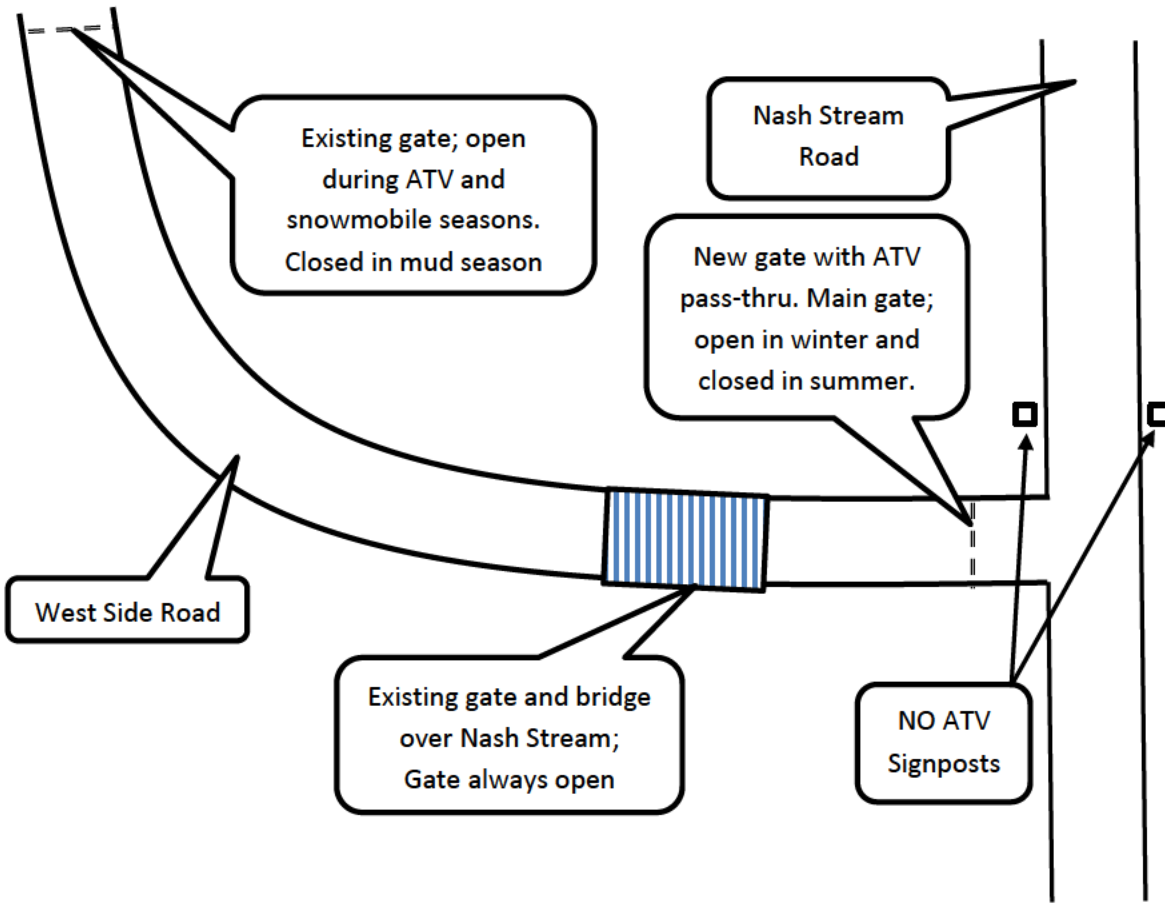

Proposed Southern Connector Trail – Nash Stream Road and West Side Road Trail Intersection



Proposed Southern Connector Trail – Nash Stream Road and Amos Emery Road Trail Intersection

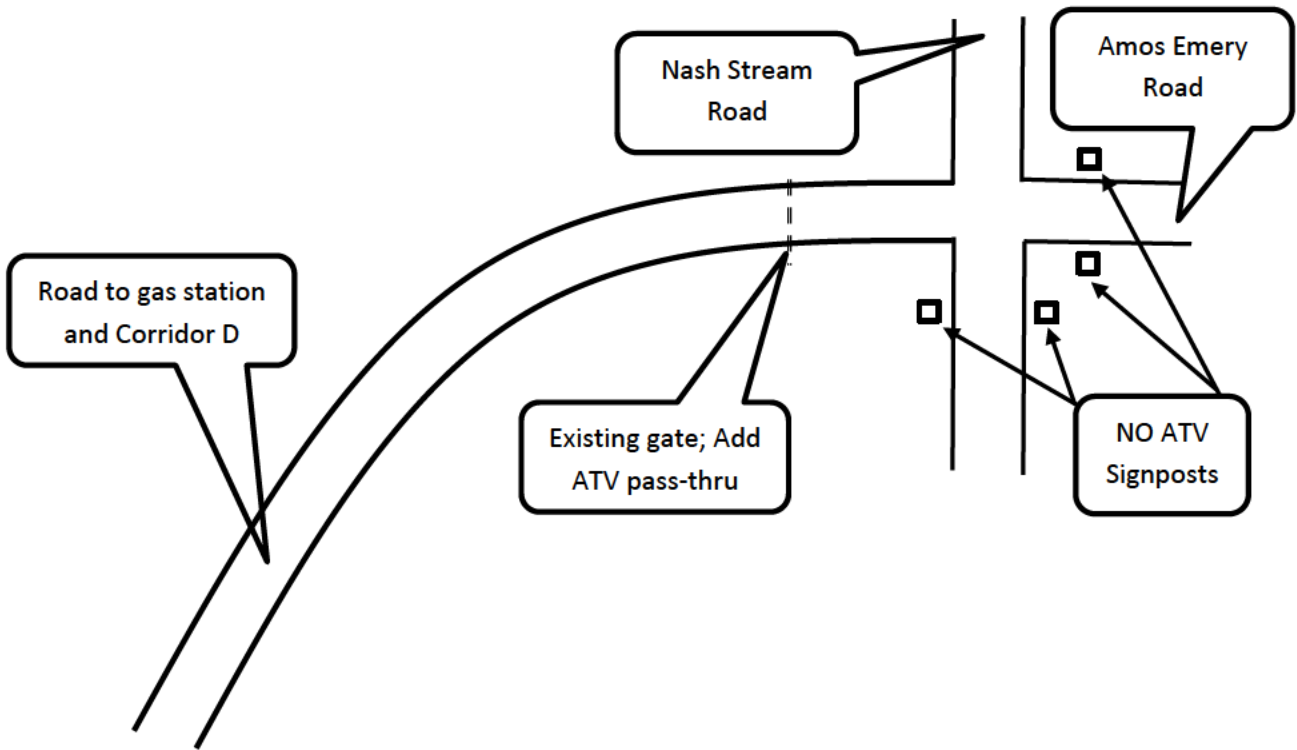

Proposed Southern Connector Trail – West Side Road Gate Details – Page 1

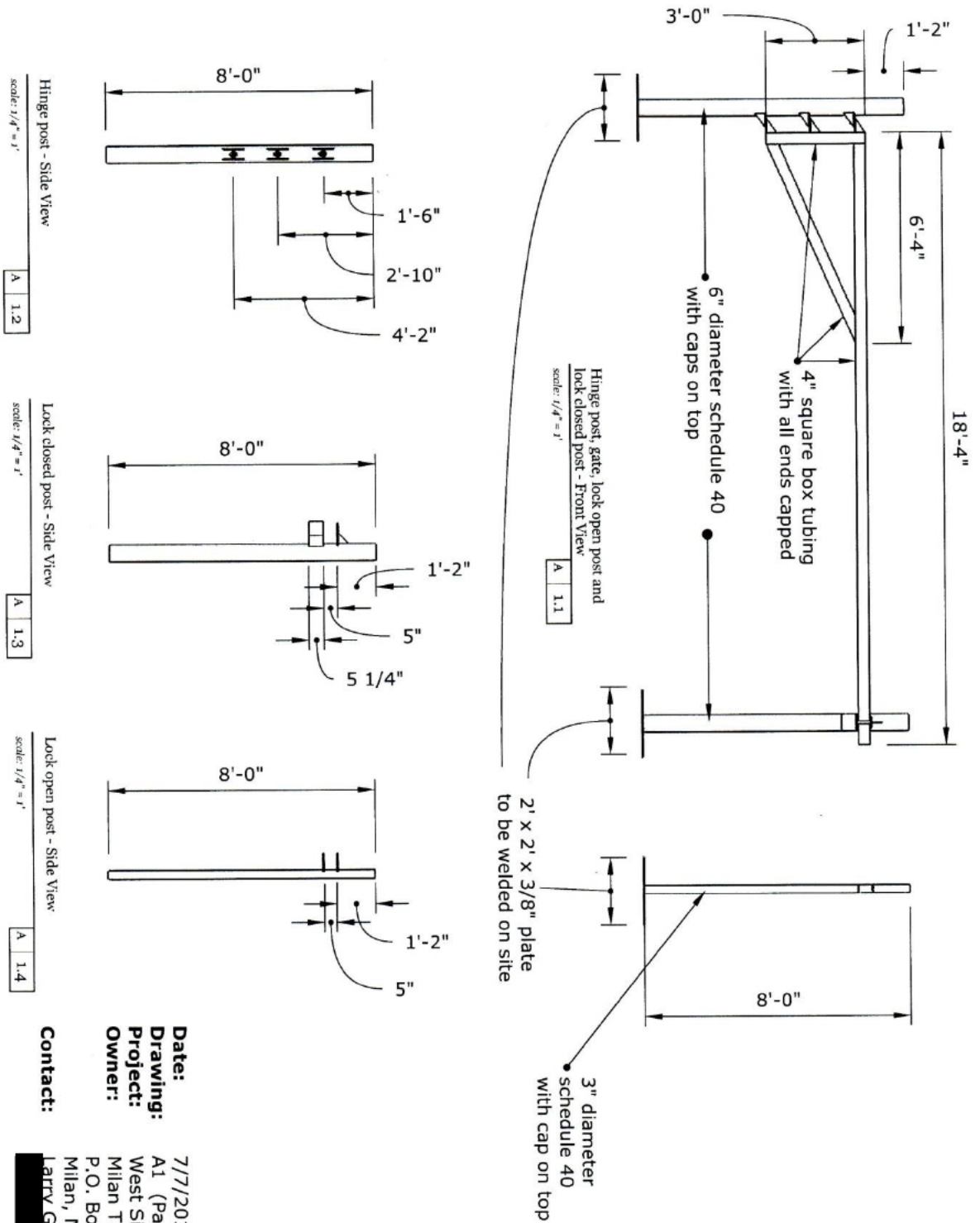

Date: 7/7/2018
Drawing: A1 (Page 1 of 2)
Project: West Side Road Gate
Owner: Milan Trail Huggers
 P.O. Box 42
 Milan, NH 03588
Contact: Larry Gomes

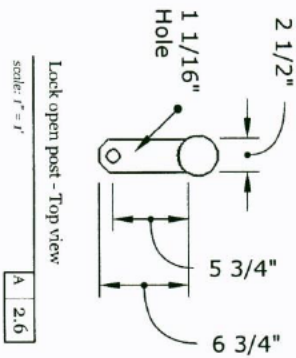
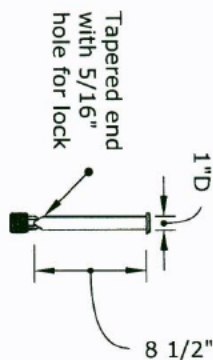
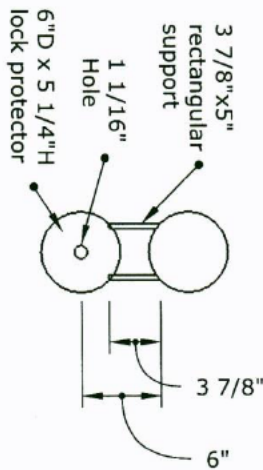
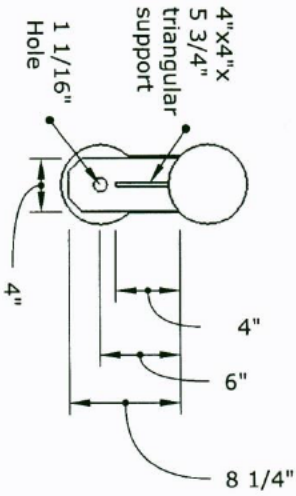
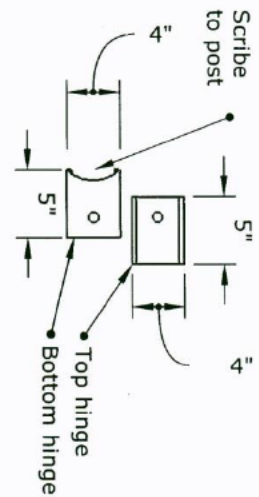
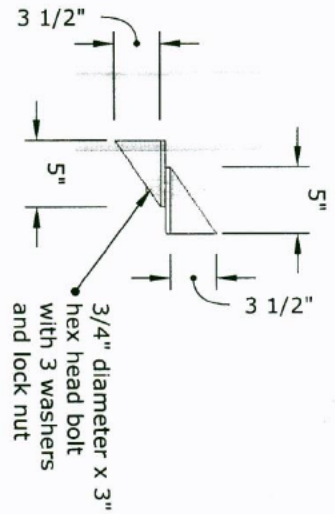

Date: 7/7/2018
Drawing: A2 (Page 2 of 2)
Project: West Side Road Gate
Owner: Milan Trail Huggers
 P.O. Box 42
 Milan, NH 03588
Contact: Larry Gomes

Proposed Southern Connector Trail – West Side Road Gate - Sample gate picture without pass-thru

